

# Protecting Perishable Foods During Transport by Truck and Rail

Jeffrey K. Brecht, Steven A. Sargent, Patrick E. Brecht,  
Jorge Saenz, and Leonard Rodowick

**UF** | IFAS Extension  
UNIVERSITY of FLORIDA





# Protecting Perishable Foods During Transport by Truck and Rail

This document is a revision of USDA AMS Handbook No. 669, Protecting Perishable Foods During Transport by Truck, last revised in 1995, which is in the public domain. The authors are grateful to USDA AMS Transportation Services Division for the funds to support the revision and publication of this handbook under Cooperative Agreement No. 17-TMTSD-FL-0007.

## *Author affiliations:*

### **Jeffrey K. Brecht,**

*Professor, Horticultural Sciences Department, University of Florida, Gainesville, FL*

### **Steven A. Sargent,**

*Professor, Horticultural Sciences Department, University of Florida, Gainesville, FL*

### **Patrick E. Brecht,**

*President, PEB Commodities, Inc., Petaluma, CA*

### **Jorge Saenz,**

*President, Wireless Data Solutions, Weston, FL*

### **Leonard Rodowick,**

*Strategic Relations – Food Safety & OEM, Thermo King Corporation, Nixa, MO*

Copyright © 2019 by the University of Florida. All rights reserved.

DOI: <http://www.dx.doi.org/10.9752/TS230.04-2019>

This report is the proprietary work product of the University of Florida, Institute of Food and Agricultural Sciences. The views and opinions expressed in this report are those of the authors and do not necessarily reflect the policies and opinions of the U.S. Department of Agriculture.

Mention of trade names or commercial products in this publication is solely for the purpose of providing specific information and does not imply recommendation or endorsement by the University of Florida or the U.S. Department of Agriculture.

An Equal Opportunity Institution. UF/IFAS Extension, University of Florida, Institute of Food and Agricultural Sciences, Nick T. Place, dean for UF/IFAS Extension.

[Back to previous page](#)

# Contents

- Preface .....vii
- I. Important Factors in Protection of Perishable Foods ..... 1**
  - Refrigeration ..... 1
    - Transport Refrigeration Basics ..... 1
      - Heat Transfer* ..... 1
      - Types of Heat* ..... 3
  - Refrigeration Methods ..... 4
    - Mechanical Refrigeration ..... 4
      - Cooling* ..... 4
      - Defrost* ..... 7
    - Ice ..... 7
    - Cryogenic Refrigerants ..... 8
  - Trailer, Railcar, and Container Design and Construction ..... 9
    - Insulation..... 9
    - Types of Transport Equipment ..... 10
      - Refrigerated Containers* ..... 10
      - Refrigerated Trailers* ..... 13
      - Multi-temperature Refrigerated Trailers* ..... 14
      - Refrigerated Railcars* ..... 15
      - Electric Powered Systems (Vehicle-Powered Systems)* ..... 16
    - Airfoils and Fuel Efficiency ..... 18
  - Transport Temperature Management ..... 20
    - Airflow Management ..... 21
      - Frozen Cargo* ..... 21
      - Chilled Cargo* ..... 23
    - Refrigeration Efficiency ..... 24
  - Packaging and Unitization ..... 26
    - Benefits of Unitization ..... 26
    - Standardized Pallet Size and Construction..... 26
    - Slip Sheets..... 27
    - Package Dimensions ..... 27
    - Package Venting ..... 28

Package Materials .....	29
Pallet Stabilization.....	30
Telematics .....	32
Cargo Space Management .....	35
Temperature Management.....	35
<i>Air Temperature vs. Product Temperature</i> .....	35
Chilling and Freezing Injury .....	36
Thawing of Frozen Foods .....	39
Atmosphere Management .....	42
Fresh Air Exchange.....	43
Controlled and Modified Atmosphere Systems .....	44
Humidification and Dehumidification Systems .....	45
Sources of Humidity.....	45
Humidity Maintenance .....	46
Dehumidification .....	46
<b>II. Preparation for Loading</b> .....	<b>47</b>
Product Temperatures and Tolerances .....	47
Adequacy of Equipment .....	49
Expert Systems .....	50
Cleaning and Sanitation .....	51
Vehicle Preparation and Maintenance .....	54
Precooling the Product and Equipment .....	55
Precooling (or Prewarming) the Vehicle.....	55
Precooling the Product.....	57
Temperature Recording and Tracking .....	58
Other Types of Recorders.....	61
<b>III. Loading and Unloading Considerations</b> .....	<b>61</b>
Type of Air Delivery System .....	62
Top-Air Delivery.....	62
Bottom-air Delivery .....	62
Type of Packaging .....	62
Whether Frozen or Non-frozen .....	65
Bracing Needs .....	65

Compatibility of Mixed Loads .....	66
Whether Palletized or Unitized .....	68
Length of Transit Period .....	69
Loading and Unloading Checklists .....	69
<b>IV. Loading (Stowage) Patterns .....</b>	<b>72</b>
Loading Trailers and Railcars with Top-Air Delivery .....	72
Unitized or Pallet Loads .....	72
Loading Containers with Bottom-Air Delivery .....	73
Unitized or Pallet Loads .....	73
Hand-Stacked Loads .....	74
Vented Loads .....	77
Top-Iced Loads .....	77
<b>V. Individual Commodity Requirements .....</b>	<b>78</b>
Fresh Fruits and Vegetables .....	78
Canned Foods .....	151
Dairy Products .....	154
Frozen Foods .....	157
Fresh and Cured Meat and Fresh Seafood .....	161
Poultry and Eggs .....	166
<b>VI. Regulatory Considerations for Truck Construction     Materials, Cleaning Compounds, and Sanitation .....</b>	<b>170</b>
<b>VII. Food Safety Considerations for Transporting     Perishable Foods by Truck .....</b>	<b>171</b>
<b>Appendix I. ....</b>	<b>176</b>
Estimating Mobile Refrigeration Requirements.....	176
Sample Refrigeration Requirement Calculation .....	182
<b>Appendix II. ....</b>	<b>185</b>
Load Compatibility Groups .....	185
<b>Appendix III. ....</b>	<b>191</b>
Recommended Protective Services for Perishable Foods During Transit.....	191

<b>Appendix IV.</b> .....	198
Sanitary Transportation of Food — Compliance Checklist .....	198
<b>Appendix V.</b> .....	200
Reefer Container Loading and Devanning Check Lists .....	200
<b>Selected Bibliography</b> .....	202
<b>Other Resources</b> .....	203



## PREFACE

This is a revision of handbook No. 669, last revised in 1995, which was itself a revision of the 1987 handbook. Handbook No. 669 superseded Agriculture Handbook No. 105, “Protecting Perishable Foods During Transport by Motortruck,” first published in 1956 and revised in 1970.

These handbooks have been extremely popular, and tens of thousands of copies have been distributed worldwide. The importance of protecting perishable foods from loss of quality during transport has long been recognized. Increased recognition of the importance of the transport link in the food distribution cold chain in securing the safety of perishable foods has more recently become as well recognized. Thus, an updated version of this handbook has been long overdue, addressing both the advances in technology and the importance of food safety considerations in the transport of perishable foods.

This updated edition reflects the dynamic changes and innovations in the handling and transportation of perishable foods. Some of these include improved insulation and air movement, microprocessors for more efficient refrigeration, expert systems to control the transport environment and conserve fuel energy, and the use of telematics to monitor and control the performance of refrigerated vehicles during transit. This edition includes descriptions and recommendations for food transported over the road and by rail in marine containers, as well as in railcars.

Many individuals and organizations provided information or other assistance in revising this handbook. Special recognition goes to the University of Florida, Institute of Food and Agricultural Science, Communications Office, for formatting the handbook and for preparing the illustrations. We appreciate the suggestions offered by those with whom we discussed this publication. A great deal of the information on recommended handling requirements for fresh fruits and vegetables is from the recently updated USDA Handbook No. 66, “The Commercial Storage of Fruits, Vegetables, and Florist and Nursery Stocks,” cited in the bibliography.

[Back to previous page](#)

# I. Important Factors in Protection of Perishable Foods

## REFRIGERATION

The object of refrigerating food products is to maintain quality and prolong shelf life by keeping the product temperature at the point where metabolic and microbial deterioration are minimized. Maintaining the desired or ideal holding temperature is a major factor in protecting perishable foods against quality loss during storage and distribution. Quality loss is a function of both time and temperature abuse. Abuse is additive and, even for short periods of time during loading, transit, and unloading, may cause a considerable amount of quality loss by the time the product reaches its destination.

Abuse can result from temperatures that are either too high or too low. For example, high temperatures cause loss of vitamin C and sugar or sucrose depletion. Low temperatures can cause chilling injury to fresh fruits and vegetables. This may not show up until the product is at the retail store or on the consumer's table, where failure to ripen properly, off-flavors, discoloration, pitting, and other signs of poor quality may be evident.

Refrigeration removes excess heat and provides temperature control for food products in transport vehicles. Heat is a positive and measurable form of energy that always radiates or flows toward the cold or refrigeration source.

In the United States, heat is measured in British thermal units (Btu). The Btu is defined as the amount of heat required to raise the temperature of 1 lb. (0.45 kg) of water 1°F (0.56°C). A metric equivalent of the Btu is the kilojoule (kj) or 1 Btu = 1.005 kj.

A truck refrigeration system must have sufficient capacity to remove heat generated by the sources described below.

## TRANSPORT REFRIGERATION BASICS

### *Heat Transfer*

Maintaining proper temperature is critical for successful transport of perishable foods. Living cargo such as fresh produce generates heat from respiration. Heat from the environment outside of the transport equipment can enter the cargo space. Some products, such as asparagus, corn, and strawberries, respire at a higher rate than other products, such as apples, oranges, and potatoes. The respiration rate varies with the temperature of

the product; it is considerably less at temperatures near freezing than at normal harvest temperatures. Table I-1 in Appendix I gives the amount of heat produced by various fruits and vegetables at given temperatures.

The purpose of transport refrigeration is to remove excess heat and provide temperature control for the shipment of perishable food products in transport equipment.

Refrigeration systems force heat to flow from inside a transport insulated cargo compartment to the outside ambient environment under most conditions. The conditioned air that intercepts heat inside the refrigerated box is freely drawn from the compartment by the fans via return air screen openings in the refrigeration unit's partition. The air that returns from the cargo compartment is forced across evaporator (cooling) coils, thus lowering the air temperature. The cool conditioned air is then moved from the refrigeration unit via the container T-bar floor, railcar ceiling plenum or the truck trailer top air delivery chute to the cargo. The refrigeration system also contains a heater, which is used during defrost cycles (see, "Defrost", below) and when the return air temperature needs to be raised rather than lowered to maintain the desired cargo temperature.

Temperature is a term that describes the amount of heat in a substance. Temperature is measured in degrees Fahrenheit or Celsius. In the Fahrenheit scale, water freezes at 32° and boils at 212°. The Celsius scale is set with 0° as the freezing temperature of water and 100° as the boiling temperature of water.

Heat is measured as calories or, in the metric (SI) system, as *joules*. In the English system, heat is measured as British thermal units, abbreviated as Btu. A measure of the flow of heat through the transport box surface area and insulation is described by a factor called the UA value. The lower the UA value, the lower the rate of heat gain across the transport box wall.

Heat is a measurable form of energy that flows from a high temperature to a low temperature source. Temperature gradients control the direction of heat flow, which can occur by three means: conduction, convection, and radiation. For example, heat naturally flows on a warm day from the outside to the inside of a refrigerated transit vehicle.

Conduction is the movement of heat through solid objects, such as the transit vehicle's insulated walls, ceilings, and doors, or between solid objects that are in direct contact with each other, such as from cargo to the walls of the cartons containing the cargo.

Convection occurs when warmer areas of gases and liquids rise to cooler areas of the gas or liquid, creating convection currents that mix the warmer and cooler areas. For instance, refrigerated airflow moves heat generated from respiring produce and heat transferred from interior walls to the transport vehicle's cooling unit.

Radiation is the transfer of heat through a gaseous medium or even empty space, such as the transfer of radiant heat generated from the sun or hot roadways to the exterior of the transport vehicle.

Heat is also absorbed and released as substances such as water or refrigerants change between their solid, liquid, and vapor phases. Heat must be absorbed for a substance change from a lower energy state to a higher energy state (solid to liquid, liquid to vapor) and energy is released when a substance changes from a higher energy state to a lower energy state (vapor to liquid, liquid to solid). This is how ice and mechanical refrigeration systems remove heat to keep products cold during transport.

### ***Types of Heat***

Three types of heat are important in refrigerated transport of perishable cargoes. These include:

1. Sensible Heat
2. Latent Heat
3. Respiratory Heat (only for fresh horticultural items)

Sensible heat is heat exchanged by a thermodynamic system or body that changes the temperature of the system or body. As the name implies, sensible heat is the heat that you can feel. The sensible heat possessed by an object is evidenced by its temperature. As temperature increases, the sensible heat content also increases. The proportionality constant between temperature rise and change in heat content is called the specific heat, measured in calories per gram per degree Celsius or joules per kilogram per degree Kelvin. Water, for example, has a specific heat of 1 Cal/g/°C. As a general rule, the gain in heat is accompanied by either a change in volume or a change in pressure (e.g., the water in the pot swells somewhat as it is heated; if gas is heated in a fixed volume, its pressure increased).

Latent heat is the heat required to convert a solid into a liquid or vapor, or a liquid into a vapor, without a change of temperature. Stated differently, latent heat is the energy absorbed or released by a thermodynamic system during a constant temperature process. Examples include ice melting or water boiling. To melt all the ice, a lot of heat has to be added; no change in the heat content is noted because ice/water system remains at 32°F (0°C). Only

after all the ice has melted does the temperature of the water increase. At this point, the added heat creates a change in sensible heat.

Sensible heat can be felt while latent heat is the type of heat that cannot be felt.

By way of example, when the internal temperature of frozen shrimp reaches about 28°F (-2.2°C), it will begin to thaw and will remain at this temperature for an extended time even when heat is steadily added. The extended time to shift the frozen shrimp temperature to greater than 28°F is due to the substantial amount of latent heat required to change the shrimp from the frozen state to the thawed state (i.e., from a solid state to a liquid state). It takes about 4½ times more heat to thaw frozen shrimp than it does to raise the temperatures of the frozen shrimp from -5°F (-20.6°C) to 28°F. When frozen shrimp thaws, there are telltale signs of thawing such as misshapen inner shrimp bags, shrimp fluid staining on cartons, cartons of frozen shrimp fused together and crushed cartons. Internal temperatures of shrimp in the outermost cartons of the stow would be the first cartons to be affected during temperature excursions and changes of state. If the internal shrimp temperatures of these outermost of cartons are affected, the operating reefer unit would record elevated return air temperatures for hours and possibly days.

## **REFRIGERATION METHODS**

In the past, several methods of refrigerating trucks have been used. These include ice, ice and salt, dry ice, hold-over plate systems, cryogenic systems, and mechanical refrigeration. Today, however, mechanical refrigeration is the predominant type. Trailers refrigerated with cryogenic refrigerants, usually liquid carbon dioxide (CO<sub>2</sub>) or nitrogen (N<sub>2</sub>), have been used to some extent but they are not as popular trailers refrigerated mechanically.

### **MECHANICAL REFRIGERATION**

#### ***Cooling***

The nature of a transport refrigeration unit, commonly called a 'reefer unit', is that a temperature differential exists between the air entering the reefer unit, (i.e., the return air), and the air exiting the unit, (i.e., the discharge or supply air) due to heat removal or addition as the return air passes through the reefer unit. The supply air usually warms as it circulates around the cargo space, picking up heat from the cargo and surfaces of walls, ceiling, and doors as it makes its way back to the reefer. However, the supply air can also cool in extreme cold environments if heat from the cargo box is

lost across the walls, ceiling, and doors. This temperature differential is distributed within an 'insulated box' and results in temperature variances and 'microenvironments'<sup>1</sup> within the cargo itself and the air surrounding the cargo. This means that the cargo itself and the air surrounding the cargo are exposed to a range of temperatures and atmospheres during transit. Controlling, modifying, and monitoring the characteristics of environments inside insulated boxes are critical to maximizing the shelf life of the cargo and, in the case of perishable foods, to optimizing the wholesomeness, safety, and quality of the food.

Mechanical refrigeration operates by absorbing heat at one point and dispensing it at another. This is accomplished by circulating a refrigerant between two points. The refrigerant picks up heat through a coil (evaporator) inside the cargo space and discharges it through another coil (condenser) on the outside. The refrigerant is circulated through the system by a compressor, which is driven by a gasoline, diesel, or electrical motor.

Transport reefer units are equipped with microprocessors that are interfaced with temperature sensors controlling the supply air and return air temperatures that are located inside the reefer unit (not inside the insulated cargo box). Supply and return air temperatures and other parameters are generally controlled and measured from inside the refrigeration units and not inside the insulated cargo box. These sensors can control the conditioned air as it is delivered to the refrigerated cargo space in the insulated box and returns back to the reefer unit to be re-cooled (or heated) and then re-circulated back to the cargo space. These sensors do not control the microenvironments that develop inside the cargo compartments of insulated boxes.

As illustrated in Figure 1 below, a refrigeration cooling system is basically comprised of a refrigeration compressor, an evaporator, a condenser, an expansion valve, piping, and refrigerant. The refrigeration system operates on the principle of the vapor-compression cycle. This refers to the physical principle that all substances must gain energy (heat) in order to change from solid to liquid and liquid to gas phases, and release energy (heat) when changing phase in the opposite direction. The temperature at which phase changes occur are characteristic of the substance and vary according to pressure – increasing the pressure increases the temperature at which the phase change occurs. Refrigerants are chosen based on their high heat

---

<sup>1</sup> A microenvironment has its own temperature, humidity and gaseous composition. See "Telematics" in section I, "Important Factors in Protection of Perishable Foods."

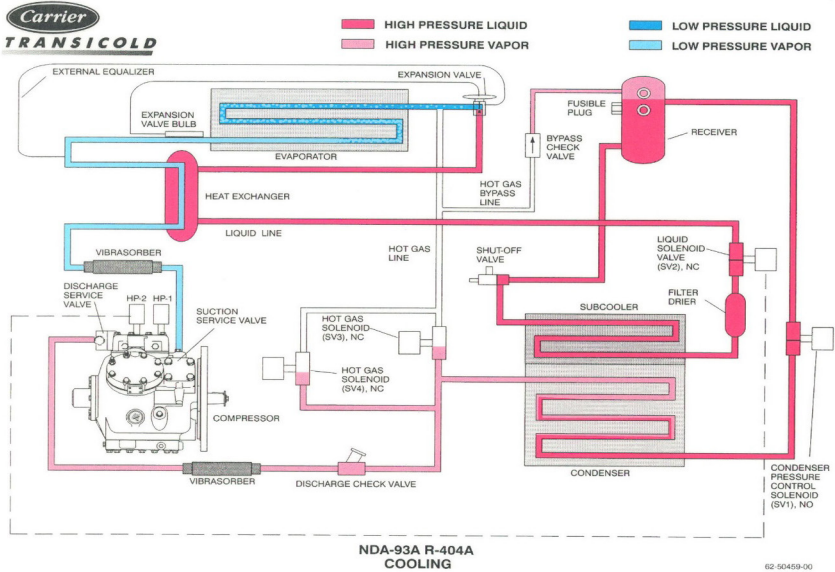

**Figure 1.** Transport refrigeration cooling system. (Source: Carrier Transicold)

capacity and ability to change phase between liquid and gas at the desired temperature.

Mechanical refrigeration units are rated according to their ability to remove or produce heat. The cooling capacity of a unit is expressed in the number of Btu's per hour a unit can remove at 100°F (38°C) outside and at 35°F (1.7°C), 0°F (-18°C), and -20°F (-29°C) inside trailer temperature. Heating capacity of the unit is measured in Btu's per hour, while inside trailer temperatures are 65°F (18.3°C) or 35°F (1.7°C) under 0°F (-18°C) ambient. (The rating procedure is based on the Air-Conditioning and Refrigeration Institute's (ARI) Standard 1110.) The refrigeration capacity needed for a particular load depends on the desired product temperature, the amount of vehicle insulation, ambient temperatures, product temperature at loading, amount of product respiration heat, and the extra capacity (reserve) desired.

Today's refrigeration units are equipped with microprocessors programmed to control the operation of the unit so that both refrigeration and fuel efficiency are maximized. Air temperatures are monitored at the discharge and return locations and adjusted to demand for refrigeration at the thermostat set-point. This reduces temperature spread around the thermostat set-point, which reduces dehydration and maintains product quality. The microprocessors also can be programmed to provide diagnostic tests and automatically run through a 'Pre-Trip' mode. Some of the microprocessors are radio-equipped



and may be contacted via satellite to monitor performance of the refrigeration unit, pinpoint geographic location of the trailer, monitor product temperatures, and perform other functions.

### **Defrost**

A refrigeration unit's evaporator coil facilitates heat transfer from the circulating air from the cargo compartment to a refrigerant that is circulated within the refrigeration system. When moisture carried from warmer air returns from the cargo compartment, it condenses on the cooler evaporator coil surface, causing moisture or ice to accumulate on the coil. Ice accumulation on the evaporator coil will eventually adversely impact conditioned airflow and refrigeration capacity. To correct this condition, manual, periodic (timed), and 'on demand' defrosts are required to clear the ice from the evaporator coil.

Inadequately precooled cargo, product loaded in a moist or wet condition, excessive fresh air exchange settings, leaking gaskets and/or door seals, and hot humid air favor moisture accumulation and icing on the evaporator coils once the doors are closed and the reefer unit is turned on. A significant source of moisture is released from fresh produce, especially if it is not precooled to the desired carrying temperature. The cold evaporator coil removes the field heat, respiratory heat, and moisture produced by the cargo, as well as the moisture from warm humid air. A typical load of produce stored in a 40-foot reefer container can contain roughly 35,000 lbs. of water (the moisture content of produce varies from about 80% to 96%). Additional water may be present if produce is wet when loaded or if ice is included in the cartons of produce.

Failure to adequately defrost the coil can result in poor temperature management, quality and food safety issues, and load rejections.

### **ICE**

Crushed or slush-ice blown over the top of produce loads is used to refrigerate and maintain high levels of humidity for certain produce items. This is known as 'top icing.' Some shippers may apply the crushed ice or slush ice to individual pallet loads or in individual boxes of product (package-icing) before loading. For package icing, up to 10 lbs (4.5 kg) of crushed ice may be placed in the cartons after packing. **CAUTION:** The ice should first be mixed with water because the temperature of plain, crushed ice can cause freezing injury to the produce. There are downsides to using top ice and package icing. To wit, top icing can restrict the movement of conditioned air and, as a result, adversely affect temperature management. Additionally, water from melted top ice can accumulate on the floor of the transit vehicle

with clogged or missing floor drains, redistribute with the conditioned air throughout the load, and potentially result in inferior temperature management. If ice is used during transport, the floor drains should be open so that meltwater will not accumulate on the vehicle floor. Ice, or rather, ice meltwater, is also considered to be a potential vehicle for cross contamination and food safety issues. Moreover, liquid water from melted packaged iced products (especially in mixed loads) can adversely affect the structural strength of non-water-resistant cartons, can result in carton instability and crushing, and corresponding damage to the perishable items packed inside the cartons.

## **CRYOGENIC REFRIGERANTS**

Cryogenic refrigerating systems, which use liquid or solid carbon dioxide (CO<sub>2</sub>) or liquid nitrogen (N<sub>2</sub>), have been available for highway trailers for many years. They are utilized primarily in delivery operations requiring 1 day or less transit time, since supplies of liquid cryogenics are generally not available at truck stops. The benefits of cryogenic transport are that they have fewer moving parts to maintain and replace, and also allow quick recovery of thermostat set-point temperature after delivery stops. Cryogenic refrigeration systems have been mostly replaced by multi-temperature refrigeration systems for short-distance deliveries.

Liquid cryogenic systems usually operate by having the liquid refrigerant in pressurized tanks. A temperature-sensing element inside the trailer activates a controller which releases the liquid refrigerant through a spray nozzle at the ceiling of the trailer. The CO<sub>2</sub> or N<sub>2</sub> spray flashes into gas as it hits the warmer air in the trailer, absorbing the heat. When the desired temperature is reached, the sensing element sends a signal to the controller to shut off the flow of refrigerant. In another type system, the CO<sub>2</sub> is circulated through a coil or plate heat exchanger and the vaporized gas vented outside. A third type of system stores CO<sub>2</sub> snow in a full-length ceiling bunker and cools as the snow melts.

**WARNING:** Allow adequate time for replenishment of O<sub>2</sub> before entering a vehicle refrigerated by CO<sub>2</sub> or N<sub>2</sub>. Workers entering a vehicle with elevated concentrations of CO<sub>2</sub> or N<sub>2</sub> gases may be rendered unconscious by the lack of O<sub>2</sub>.

Also, high concentrations of cryogenic refrigerant gases (generally above 20%) may have an adverse effect on fresh produce. Most fresh fruits and vegetables will eventually suffocate in a 100% N<sub>2</sub> atmosphere, although many products will tolerate high levels of N<sub>2</sub> for a few days without injury. High percentages of CO<sub>2</sub> gas in the atmosphere may cause off-flavors,

off-colors, and physiological disorders in fresh produce. On the other hand, moderate concentrations of this gas are successfully used to retard decay and ripening of fruits and vegetables during transit and storage. Generally, N<sub>2</sub> atmospheres are not harmful to food products, and CO<sub>2</sub> atmospheres help retard microbial growth on fresh meat and meat products (see “Controlled and Modified Atmosphere Systems”). Neither CO<sub>2</sub> nor N<sub>2</sub> gas will harm frozen foods.

Solid CO<sub>2</sub> (dry ice) may be in the form of blocks, snow, or pellets, all of which are used as refrigeration mediums in transport vehicles. The most frequent use of solid CO<sub>2</sub> is in frozen food and ice cream delivery trucks. Solid CO<sub>2</sub> may be used as an emergency refrigerant in the event of mechanical unit breakdown in vehicles hauling frozen products. Dry ice changes into gas at -109°F (-78.3°C).

## **TRAILER, RAILCAR, AND CONTAINER DESIGN AND CONSTRUCTION**

Vehicles used for temperature-controlled transport are similar in construction and outward appearance to those in general freight service, but they have three fundamental differences:

1. Insulation that is usually foamed in place
2. Provisions for conditioned air circulation (airflow) through and around the cargo
3. Machinery for cooling and/or heating

Design and performance considerations include the following:

- Extremes of exterior conditions: temperature, relative humidity, wind, pressure, shock, vibration and radiant heat
- Carrying conditions: temperature, atmosphere and relative humidity
- Insulation properties: thermal conductivity, moisture permeability and retention, chemical and physical stability, adhesion, uniformity of application, fire resistance, cost of material and application, and presence of structural members
- Infiltration of air and moisture
- Trade-offs between construction cost and operating expense (sometimes referred to as ‘value engineering’)

### **INSULATION**

Vehicles used to transport perishable food products should be well insulated to retard the flow of heat through their walls, floors, doors and ceilings.

Insulating quality is measurable, and the industry standard is the U factor (coefficient of heat transfer through a transport equipment body). The lower the U factor, the better the insulation.

The majority of refrigerated transport vehicles are insulated with polyurethane foam insulation. Polyurethane foam insulation provides excellent insulating performance. It is lightweight and low cost. Insulating performance degrades over time. To wit, as railcars, trailers and containers age, their UA value increases as insulation deteriorates with age, and they become more susceptible to increased heat transfer and air leakage, especially around the rear doors. Consequently, older insulated transport boxes have less insulation capacity than newer ones, and a greater potential to enable perishable product warming. Additionally, older, less thermally efficient transit equipment requires more fuel to power refrigeration units than newer units.

Due to the movement of water and air into the gas bubbles and voids within the polyurethane foam insulation, a refrigerated transport box will experience about 5% degradation in insulation performance every year. Within five years, insulation performance may decrease about 25% compared to when the trailer was new.

Notwithstanding, transport refrigeration units are often equipped with extra refrigeration capacity to help compensate for diminished UA values as the insulated boxes age. Therefore, it is necessary to purchase a trailer with more insulation than needed initially, as well as select a cooling unit that has excess capacity.

## **TYPES OF TRANSPORT EQUIPMENT**

### ***Refrigerated Containers***

A refrigerated container, also known as an integral reefer container, is an intermodal shipping container that is used for the transportation of temperature sensitive cargoes. The container's reefer unit is located inside the cargo compartment (Figure 2). Refrigerated containers can be transported over land and sea by trains, trucks, and vessels.

The three main components of a refrigerated container are the refrigeration system, the microprocessor controller, and the air circulation system (chilled or heated air system). A reefer container is a metal box with polyurethane-insulation and an attached electric-powered cooling (refrigeration) unit. Reefer containers are equipped with a microprocessor/data logger function that controls the operation of the reefer machinery, documents the pre-trips (system maintenance and diagnostic checks), and records temperatures and various events during transit.



**Figure 2.** External views of refrigerated containers showing an integral refrigeration unit attached to an insulated container (box) and a chassis. (Source: PEB Commodities, Inc.)

Reefer containers are equipped with a bottom-air delivery system (also known as reverse air flow). The conditioned air is delivered from the reefer unit located at the front of the reefer container, along the floor, through the ‘T’ floor channels, and up vertically through the cargo so that the air is driven around and through the load to maintain product temperatures

(Figure 3). This type of airflow system pressurizes the ‘T’ floor with conditioned air when the cargo is properly stowed in the container. The pressurized air is forced a short distance up and through the cargo vertically from the ‘T’ floor to the top of the load and back to the reefer unit. A bulkhead (plenum or false wall) at the front of the container directs the discharge air out at floor level and allows the return air to flow back to the reefer only at ceiling level.

Reefer containers have an adjustable fresh air exchange opening that is set to avoid potentially injurious depletion of oxygen ( $O_2$ ) or build-up of carbon dioxide ( $CO_2$ ) and ethylene ( $C_2H_4$ ) gases. Figure 4 shows a picture of a fresh air exchange device on a marine container to allow varying rates of gas exchange to occur. The fresh air exchange is usually set manually, but automated systems are also available that are controlled by the refrigeration system microprocessor. Automated fresh air exchange systems are able to keep the fresh air exchange closed as much as possible to improve temperature pull-down and reduce fuel usage, maintain a beneficial atmosphere of  $O_2$  and  $CO_2$ , or avoid infiltration of freezing or chilling outside air that may damage the products being carried.

The reefer unit is self-contained, but it does require a power source. The operation of integral reefer units relies on electrical power sources such as

land-based sites, container ships, and diesel-powered generators (known as ‘gen sets’) that attach to the container or chassis. The refrigeration unit is powered by connecting the reefer container to an electrical supply through the container’s electrical plug. The electrical power supply must be either 380 volts/50 hertz or 440 volts/60 hertz and the power cables must have standard ISO plugs. Gen sets can attach to either the upper forward end of the container (clip-on gen set – see Figure 5) or the chassis (underslung gen set) while on road or rail journeys. Gen sets have a fuel tank capacity of 39 to 120 gallons, which equates to a running time of about 1½ to 5 days.

Reefer containers are intermodal in that they can be loaded onto container vessels for marine transport, then upon arrival at a port they can be transferred to a chassis for over-the-road truck transport (Figure 6), or transferred to a rail stack car or flatcar, stacked one or two high, for rail transport (Figure 7). The ride on a stack train is substantially smoother than for a rail flatcar or a container on a chassis.



**Figure 3.** Interior view of a refrigerated container showing corrugated sidewalls, ‘T’ bar floor, return air register, and front bulkhead. (Source: PEB Commodities, Inc.)



**Figure 4.** Picture illustrating manual fresh air exchange within a reefer container. (Source: PEB Commodities, Inc.)



**Figure 5.** Clip-on gen set mounted to a refrigerated container. (Source: PEB Commodities, Inc.)

## Refrigerated Trailers

Reefer trailers generally consist of an insulated trailer (box) on wheels and a direct-drive reefer unit that is located outside the refrigerated trailer's cargo compartment (Figure 8). Reefer trailers are usually used only for over-the-road truck transport, but may also be carried by rail.

In contrast to reefer containers, reefer trailers are routinely equipped with a top-air delivery system, which means that the air is delivered from the reefer unit to the cargo space via an air delivery chute attached to the trailer's ceiling (Figure 9). The conditioned delivery air from the reefer flows horizontally over the load to the rear doors, then back through and around the load and along the floor, though an opening at the bottom of the front bulkhead, and back to the reefer unit. The placement of heat generating cargo must permit the conditioned air to pass between the load, the walls, and the floor. Frozen cargo is loaded into the trailer as a solid block in such a way that the conditioned air can flow around the outside of the cargo to



**Figure 6.** A reefer container on a flatbed trailer, being hauled by truck. (Source: Maersk)



**Figure 7.** Reefer containers double-stacked on a rail stack car. (Source: American President Lines)



**Figure 8.** External view of trailer, refrigeration unit and insulated trailer.  
(Source: Thermo King)



**Figure 9.** Interior view of refrigerated trailer showing flat sidewalls, duct extension, air delivery chute, pressurized return air air bulkhead, a duct extension, and an air delivery chute attached to the ceiling of a reefer trailer. (Source: PEB Commodities, Inc.)

intercept heat from outside the trailer before it can affect the cargo. The air returns horizontally around the cargo, under the front bulkhead, and back to the reefer unit. The horizontal airflow system moves conditioned air passively while picking up heat along the way from the rear of the load to the front bulkhead.

Like reefer containers, reefer trailers are equipped with a microprocessor/ data logger function that controls the operation of the reefer machinery, documents the pre-trips (system maintenance and diagnostic checks), and records temperatures and various events during transit. Intelligent reefer trailers are equipped with an array of options, including the creation of product profiles by adjusting the system's full set of operating parameters to fit the individual perishable commodities that are transported on a regular basis.

### ***Multi-temperature Refrigerated Trailers***

There has been a steady growth in the use of multi-temperature trailers for food delivery operations, especially for fast food and independent grocery stores.

Multi-temperature reefer trailers are reefer trailers that can typically be divided into two or three compartments to allow transport of cargo



simultaneously in different temperature zones. Three zone compartments are separately controlled at 0°F (-18°C) or below for frozen foods, around 35°F (1.7°C) for chilled foods, and around 55°F (12.8°C) for sensitive chill products.

Trucks and trailers with multiple interior compartments operating at different temperatures require a multi-temperature refrigeration unit. A moveable insulated bulkhead typically separates the different compartments, and remote parallel evaporators are connected to the main refrigeration unit, which is connected to the front wall. The trailers are equipped with side doors so that the individual compartments can be loaded and unloaded independently. Figure 10 shows a typical trailer multi-temperature system with two zones.

**Refrigerated Railcars**

Railcars utilize the same basic refrigeration units as truck trailers with computerized controlling and recording devices (Figure 11). The refrigeration unit’s datalogger records and controls the supply and return air temperatures in the front bulkhead of the refrigeration unit (i.e., ‘A’ end of railcar).

Refrigerated railcars are equipped with a top air delivery system, which means that the air is delivered from the refrigeration unit to the cargo compartment via a vented air delivery plenum that is attached to the ceiling (Figure 12). The conditioned air flows between the load, the side walls, and the rear doors, then back along a floor plenum to the refrigeration unit through the bulkhead. The placement of cargo and pallets must permit the conditioned air to pass between the load, the walls and the floor.

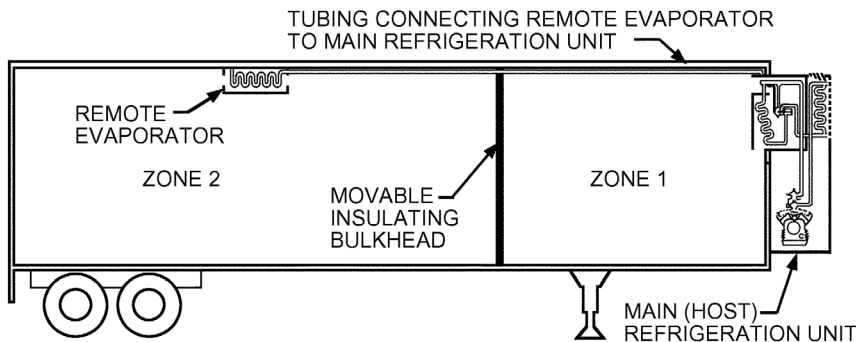
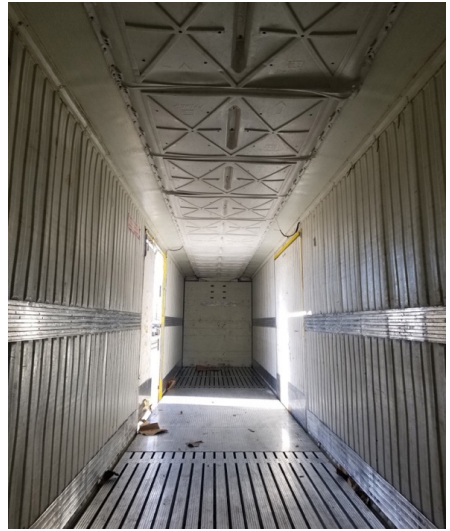

**Figure 10.** Diagram of a multi-temperature refrigerated trailer showing use of a remote evaporator and moveable bulkhead separating the compartments. (Source: ASHRAE)



**Figure 11.** External view of refrigerated railcars. (Source: UPRR)

---



**Figure 12.** Internal view of a refrigerated railcar. (Source: UPRR)

---

Like reefer trailers, intelligent refrigerated railcars can be equipped with an array of options including the creation of product profiles by adjusting the system’s full set of operating parameters to fit the individual perishable commodities that are transported on a regular basis.

### ***Electric Powered Systems (Vehicle-Powered Systems)***

Vehicle-powered refrigeration units, as the name suggests, draw power from the vehicle’s propulsion system. This type of system is typically applied to small trucks and vans used for local delivery of refrigerated products. For this type of system, the compressor can be mechanically driven, typically through a belt and pulley, from the engine as shown in Figure 13, with all other refrigeration components driven electrically off the vehicle battery. As with self-powered trucks, a condenser and evaporator fan-coil package is installed at the front top over an opening to accommodate the evaporator and its fan(s), and top air delivery is generally used. The engine-mounted compressor requires interconnecting discharge and suction lines to the condenser and evaporator sections in the truck body. Performance of this type of system arrangement is controlled by the vehicle engine’s rotational speed, and varies independently of refrigeration capacity requirements; thus, the idle speed is often artificially increased. The electric current output of the battery charging alternator on the vehicle engine is often increased to handle the greater load imposed by the electric evaporator and condenser fan motors.

An all-electric vehicle-powered truck system, as shown in Figure 14, is powered by an electric alternator that is driven by a belt either from the engine crankshaft or the engine power take-off (PTO). Electrical power is wired to the refrigeration unit, which allows use of a hermetic or semi-hermetic compressor and electric fan motors. This basic arrangement suffers the same drawbacks as a belt-driven compressor system with regard to varying engine speed.

To address this issue, a conditioning system (static converter) that manages the delivered electrical power can be installed between the alternator and the refrigeration unit. The conditioning system uses an intermediate DC circuit to maintain a constant DC voltage. Variable-frequency AC voltage can then be independently supplied to an induction compressor motor and condenser and evaporator fan motors. A static converter is therefore an important component of the electrical power supply of a self-powered refrigeration unit used in electric or hybrid vehicles. The static converter input is connected to the vehicle high-voltage DC bus. The high DC bus voltage can vary over a broad range during vehicle operation, and the static converter keeps voltage constant in the intermediate circuit. Close cooperation between controllers

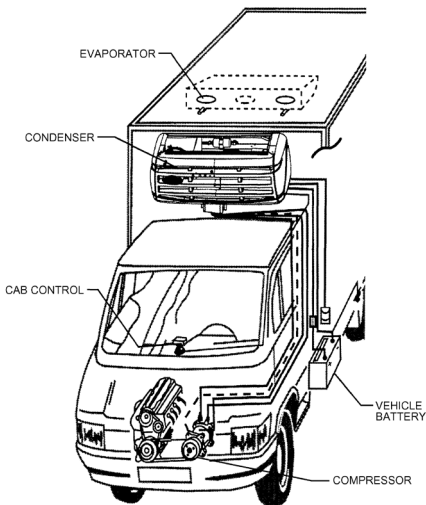

**Figure 13.** Small Truck Refrigeration System (Engine-Driven Generator) in which the refrigeration system compressor is mechanically driven by the truck's engine, and the other refrigeration components are powered by the truck's battery. (Source: ASHRAE)

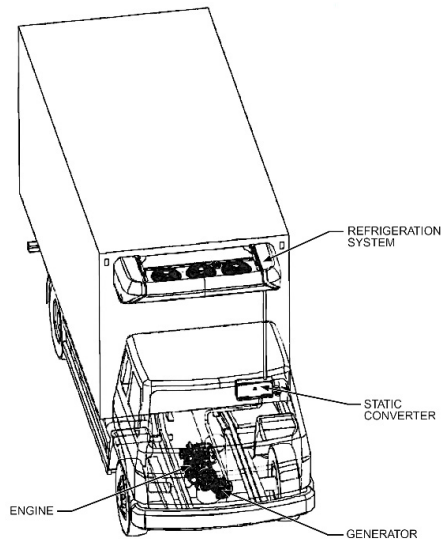

**Figure 14.** Small Truck Refrigeration System (Electric-Engine-Driven Generator), in which the refrigeration system is powered by an electric alternator connected to the truck's engine. (Source: ASHRAE)

of the vehicle propulsion system and refrigeration unit is necessary to avoid overloading the vehicle propulsion system.

## AIRFOILS AND FUEL EFFICIENCY

Improving the fuel efficiency of over the road vehicles for food transport is important for reducing transportation costs. Aerodynamic losses account for about 20% of total energy usage; rolling resistance of the tires causes an additional 12% energy usage. Maintaining recommended tire pressure minimizes rolling resistance and is one of the easiest means to increase overall efficiency.

The locations of the tractor-trailer that cause the most aerodynamic drag on the vehicle include 1) the front ends of the tractor and the trailer, 2) the space between the cab and the trailer, 3) the tractor rear wheels, the trailer undercarriage and rear wheels, and 4) the turbulence at the rear end of the trailer (Figure 15). The availability and adoption of drag-reducing airfoils can potentially boost fuel efficiency up to 15%, with annual savings estimate of over \$3,600 per truck (U.S. E.P.A., 2004).

Aerodynamic drag at the above points of resistance can be reduced by the addition of nose cones, gap fairings, belly fairings (trailer skirts), underbody fairings and boat tails (Figure 16a-e). However, when considering adding these accessories, it is critical that the airfoils be compatible with the variety of dimensions that are encountered between tractors and trailers. They are often interchanged, particularly in fleet operations. For example, an airfoil to minimize drag in the gap between the tractor and trailer must be short enough to avoid crushing during turns. Too little clearance underneath the trailer can cause belly and underbody fairings to drag on the ground.

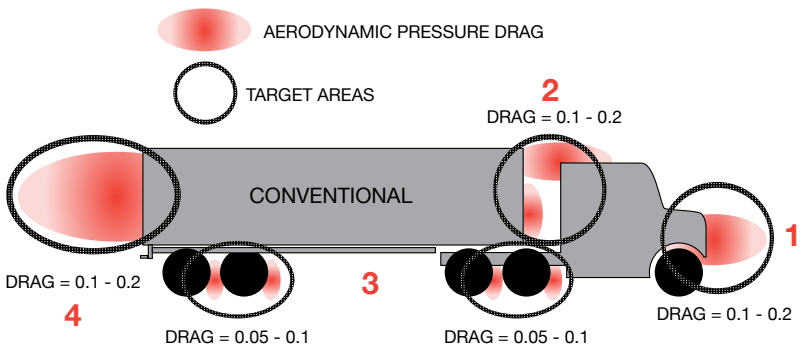

**Figure 15.** Locations of the tractor cab and trailer that cause significant drag on the vehicle. (Source: Curry et al., 2012; [https://www.theicct.org/sites/default/files/publications/AERO\\_RR\\_Technologies\\_Whitepaper\\_FINAL\\_Oct2012.pdf](https://www.theicct.org/sites/default/files/publications/AERO_RR_Technologies_Whitepaper_FINAL_Oct2012.pdf))

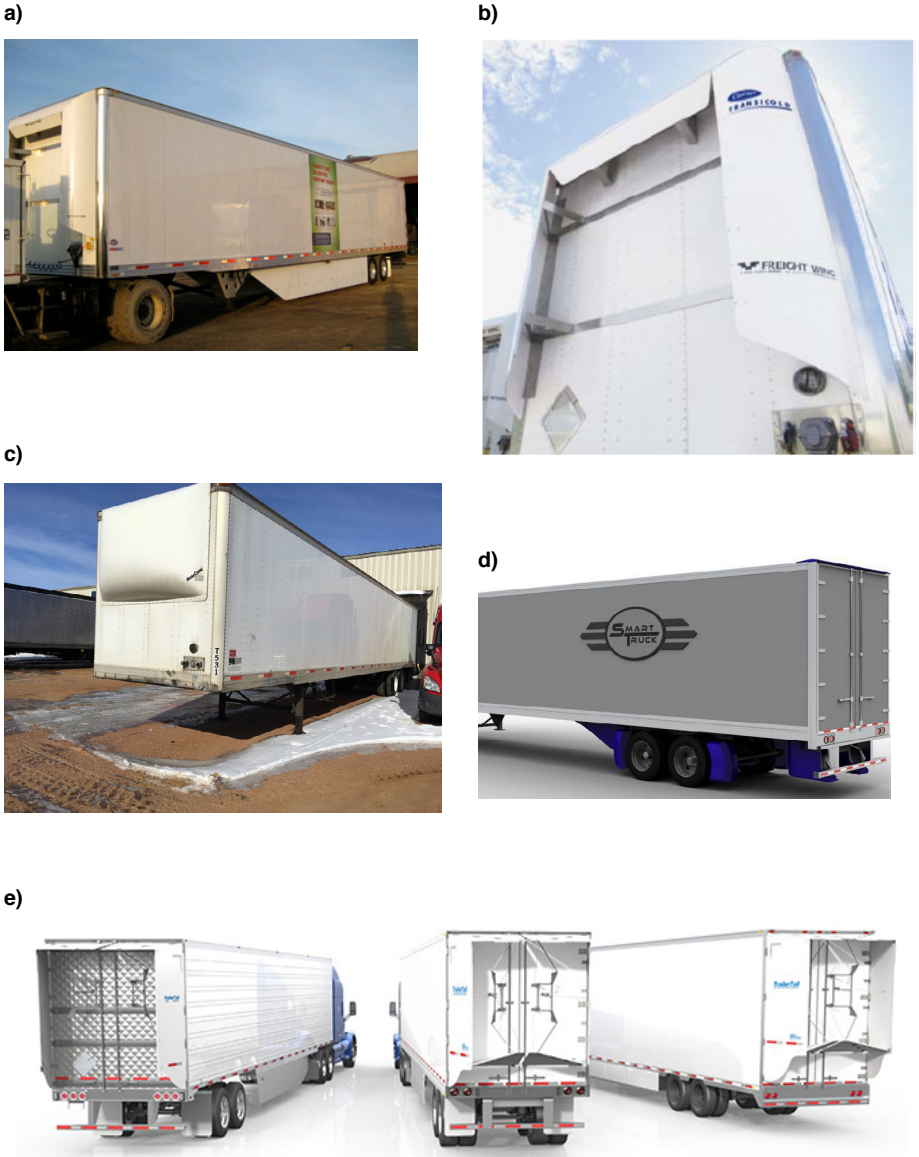

**Figure 16.** Airfoil accessories to increase fuel efficiency. a) nose cone, b) gap fairing between tractor and trailer, c) belly fairing, d) underbody fairings, e) boat tails. (Source: Curry et al., 2012; <https://www.theicct.org/publications/reducing-aerodynamic-drag-and-rolling-resistance-heavy-duty-trucks>)

Extended boat-tail airfoils may be a traffic hazard if not properly secured. Large companies typically evaluate retrofit airfoil accessories based on a 2- to 3-year payback period to be considered cost-effective in reducing fuel consumption.

## **TRANSPORT TEMPERATURE MANAGEMENT**

Temperature management plays the most significant role in extending the market life of perishable foods. Bringing the product to its desired carrying temperature as quickly as possible and maintaining uniform temperatures is paramount for domestic and global distribution. The practice of maintaining optimum temperatures throughout the perishables distribution system without any breaks is often referred to as ‘maintaining the cool chain.’

Refrigeration units for containers, trailers, and railcars are equipped with computerized controls and recording capabilities. The computer or microprocessor is sometimes referred to as a Data Management System (DMS) or a data logger. Computerized refrigeration units offer significant benefits to transportation companies, drivers, shippers, and receivers. To wit, the microprocessor controls, tracks, and records operations of the refrigeration system, including, in part, the temperature set point, return air sensing, discharge air sensing, operating modes, safety alarms, and probe sensing. Temperatures can be recorded in either degrees Celsius (°C) or Fahrenheit (°F). The microprocessor also performs pre-trips and diagnostics of the refrigeration unit and records operational events and alarm codes. The refrigeration unit’s computer system offers various levels of guarded access, thereby protecting the refrigeration unit from tampering and unwelcome changes. Trip data can be retrieved (but not erased) from the microprocessor memory.

The DMS also permits the operator to set up pre-determined temperature management conditions including upper and lower critical control limits for perishable foods. Product storage guidelines can be utilized to help set up carrying temperature parameters for perishable and temperature-sensitive products transported using containers, trailers, and railcars equipped with these refrigeration units.

As explained in “Transport Refrigeration Basics,” in a refrigerated transport unit, a temperature differential exists between the air entering the refrigeration unit, (i.e., the return air), and the air exiting the unit, (i.e., the supply air). This temperature differential continues into the cargo space, creating microenvironments within the cargo and the air surrounding the cargo. Microenvironments represent distinct and unique environments

within the cargo space of the refrigerated container, trailer, truck, railcar, or air container. Controlling, modifying, and monitoring the characteristics of microenvironments inside insulated boxes are critical to maximizing the shelf life of the perishable cargo and optimizing the wholesomeness, safety and quality of food.

A transport refrigeration system must have sufficient cooling capacity to remove the heat generated from all sources. Heat transfer into an insulated transport box is augmented by differences between outside and inside air temperatures, surface area of the insulated box, color of exterior finishes, amount and effectiveness of insulation (UA values) in walls, ceilings, floors, and doors, excessive air leakage into the insulated box caused by poor door seals and wall damage, and warm air infiltration when doors are opened and/or when the fresh air exchange vent setting is excessive.

## **AIRFLOW MANAGEMENT**

Air circulation is one of the most important factors in protecting refrigerated loads of perishable foods. Air circulation is important to ensure uniform temperatures throughout the load. Refrigeration capabilities are meaningless if the refrigerated air is not properly circulated to maintain product temperature. Air circulation carries product heat and the heat which penetrates the walls, floors, and ceiling of the trailer to the refrigeration unit where it can be removed. Heated air may be circulated to keep fresh produce from incurring chilling or freezing injury.

There are two major methods of circulating air in refrigerated vehicles. Top-air delivery is the conventional method for refrigerated truck and railcars (Figure 17). The second method is bottom-air delivery, which has been employed extensively in seagoing van containers for several decades, but only to a limited extent in highway trailers (Figure 18). Ribbed (fluted) sidewalls or spacers at least 1 inch (3 cm) thick to allow top airflow down the sides of the load. This reduces the amount of heat conducted across the walls to or from the product. Up to 20% of the top airflow should bleed off down the sidewalls. Vertical channels or fluted rear doors and sidewalls facilitate air flow and prevent the blocking of air circulation between the load and the rear doors and sidewalls. In this section, the pathways of airflow in top- and bottom-air delivery trailers respectively are discussed and illustrated.

### ***Frozen Cargo***

Frozen products are stowed as a solid block, centered within the cargo space so that conditioned air envelopes the cargo to isolate it from outside heat sources. This is especially important for vehicles with flat walls. Vertical

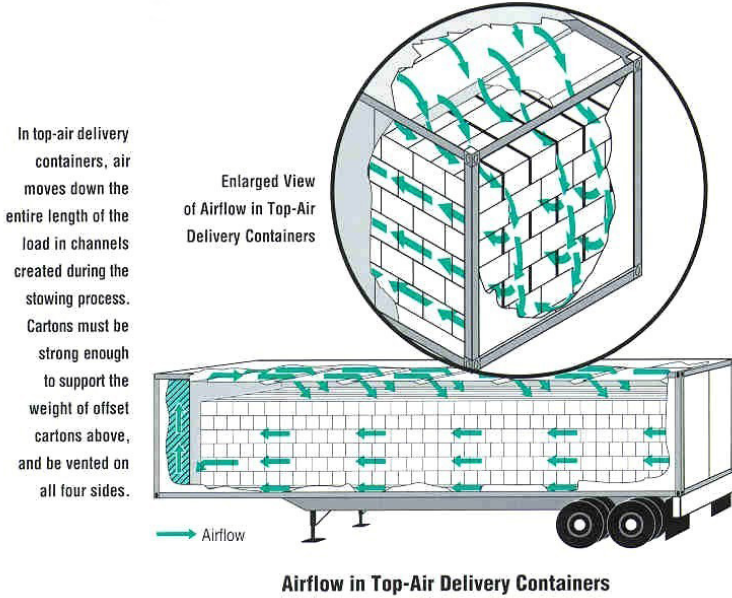

**Figure 17.** Diagram illustrating top-air flow within a truck trailer. (Source: Brecht, P.E., 1992, Shipping Special Commodities. American President Lines, Oakland, CA.)

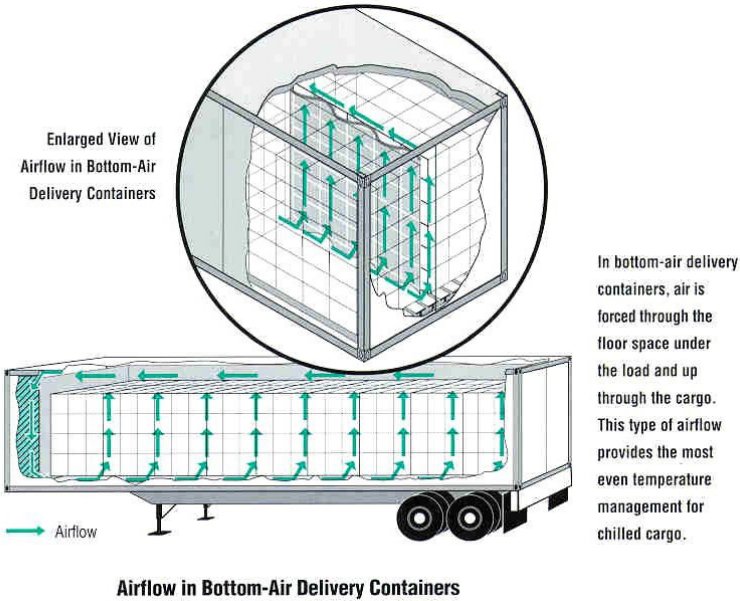

**Figure 18.** Diagram illustrating bottom-air flow within a reefer container. (Source: Brecht, P.E., 1992, Shipping Special Commodities. American President Lines, Oakland, CA.)



channels or fluted rear doors and sidewalls facilitate air flow and prevent the blocking of air circulation between the load and the rear doors and sidewalls.

### ***Chilled Cargo***

When shipping heat-generating fresh produce in refrigerated equipment, special packaging and loading practices are required. Proper product packaging, carton designs, unitization, and stowage are needed to ensure that the conditioned air is capable of evenly and effectively removing heat while maintaining non-injurious or beneficial levels of gases such as CO<sub>2</sub>, O<sub>2</sub>, and C<sub>2</sub>H<sub>4</sub> within the load. This means that fresh produce packaging must have adequate vented area, with the venting oriented to match the transportation equipment airflow pattern, in order to facilitate conditioned air flow through the product mass. In some cases, fresh produce containers are stowed so as to create air channels between the produce containers that facilitate air flow through the product mass. If the conditioned air does not reach the produce within the middle of the load, heating will occur, leading to quality deterioration.

Air, like any gas, will follow the path of least resistance. If the cargo in refrigerated equipment is stowed in such a way as to allow conditioned air to prematurely return back to the refrigeration unit ('short cycling'), the perishable items stowed progressively away from the refrigeration unit will not receive the climate control protection required (Figure 19).

The goal of good airflow management is to circulate air around and through each chilled perishable item and to surround the entire load with conditioned air. The key to success is to permit conditioned air to flow unrestricted around the perishable items within the packages and to all six sides of the load. To optimize airflow management, proper stowage of the cargo in the transport vehicles is essential (see section IV, "Loading (Stowage) Patterns").

Transport refrigeration units are designed to maintain desired temperatures and generally have plenty of cooling capacity to remove produce respiratory heat and heat conducted across the walls, doors, ceiling, and floor of the transit vehicle. With very few exceptions such as fresh bananas, which are carried at relatively high temperatures to avoid chilling injury, the refrigeration units do not typically possess sufficient cooling capacity to remove field heat from fresh produce in order to bring the cargo temperature down to the proper carrying temperature. Perishable products should therefore already be at or very near their desired carrying temperature at the time they are loaded into the transport equipment. In any case, proper air distribution in transport vehicles is essential to remove respiratory and environmental heat and uniformly maintain air and product temperatures throughout the load.

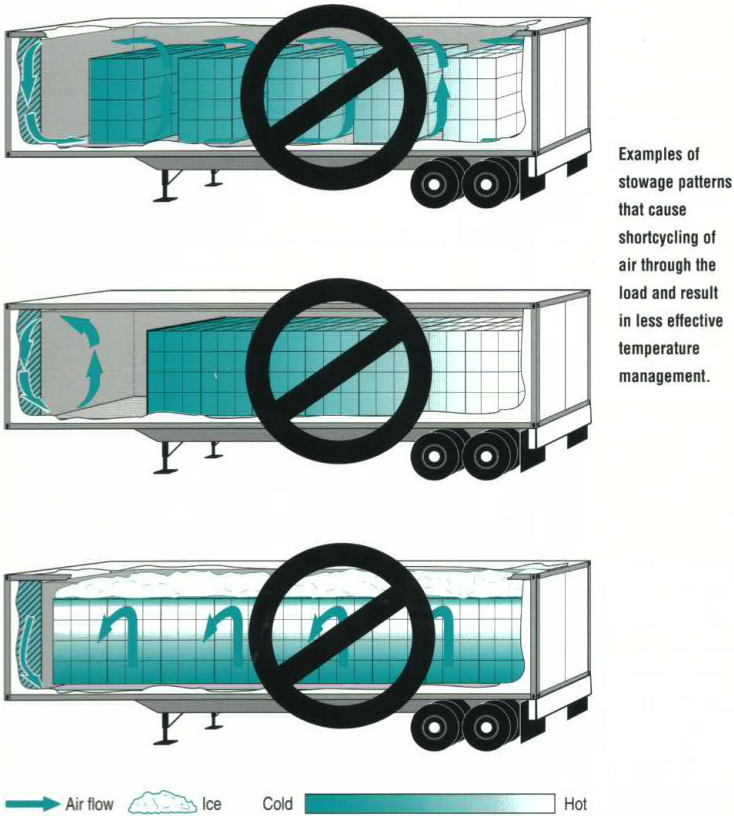

**Figure 19.** Diagram illustrating short cycling of conditioned air within a bottom-air flow reefer container. (Source: Brecht, P.E., 1992, Shipping Special Commodities)

Inadequate air distribution is a major cause of perishable cargo losses even with optimally designed refrigerated units and trailers.

### REFRIGERATION EFFICIENCY

A transport refrigeration unit (TRU) is defined as a refrigeration system powered by integral internal combustion engines designed to control the environment of temperature sensitive products that are transported in trucks and refrigerated trailers. TRUs may be capable of both cooling and heating. If the engine powering the unit is diesel-fueled, then it is a TRU. If the refrigerator is powered some other way, besides a diesel engine, it is referred to as a transport refrigerator (TR).

There is an array of energy saving options available for refrigerated transport units. For example, reefer trailer and railcar units are equipped with a number of operating modes, such as Continuous Run and Start-Stop (also known as Cycle Sentry).

The Start-Stop mode of operation means that the refrigeration unit starts and stops based on preset criteria. The Start-Stop operation is based on thermostat setpoint and the return air temperature. It allows the reefer unit direct drive engine to shut down when return air temperature has reached setpoint. Because the engine is not consuming fuel or accumulating engine hours, it is saving energy and money. However, Start-Stop is not universally recommended for all perishable cargoes. The Start-Stop setting can be used with selected frozen cargoes, but it should not be utilized for fresh produce and other temperature sensitive cargoes.

In the Continuous Run operation, the refrigeration unit runs all the time and the direct drive diesel engine that powers the refrigeration system will not shut down except for 'safeties' or if the engine stalls. The engine continues to burn fuel and accumulate engine hours. The air inside of the trailer is always moving. This is good for fresh produce. To maintain product quality the unit must operate in Continuous Run. There is a trade-off between economy and product quality. The Continuous Run mode should be used for chilled meat, fresh produce and other temperature sensitive cargoes as these cargoes need continuous airflow and temperature management. In the case of fresh produce, continuous run is also needed to remove the respiratory heat produced by the produce. In short, continuous airflow and temperature management allows for more consistent cargoes temperatures throughout the trailer for the duration of transport.

Single-temperature hybrid diesel-electric reefer trailer refrigeration units are also available; these units offer reduced weight, improved fuel economy and greater refrigeration capacity.

All of the "most promising" TR technologies have similar key performance parameter issues and deployment challenges:

- Limited fueling infrastructure currently exists;
- Fueling infrastructure costs are significant; and
- Limited range means these technologies are not an option for long-haul until publicly accessible infrastructure is installed along major transportation corridors for Class 8 semi-trailers (e.g., electric power plugs, H2 refueling, cryogenic fluid "refueling"); until then, TRs are only potentially feasible for fleets that return to base each day where refueling infrastructure could be installed.

Significant improvements in energy efficiency are also possible for conventional TRUs. Many of these energy efficiency improvements could also help to make the TR technologies discussed herein more viable by extending their range (hours of operation between fueling).

For refrigerated containers, energy saving systems have also been introduced. One such system is called Compressor-Cycle Perishable Cooling (CCPC), or Quality and Energy in Storage and Transport (QUEST). CCPC/QUEST is a method of temperature control used during steady-state perishable cooling. The systems cycle the compressor on and off according to supply and return air temperature conditions. The system's program is designed to reduce the energy consumption of the refrigerated containers, when operating in the interval 30°F to 86°F (-1°C to +30°C).

## **PACKAGING AND UNITIZATION**

### **BENEFITS OF UNITIZATION**

Perishables typically undergo several handling transfers by the time they reach the final destination. Many of these products, in particular fresh fruits and vegetables, eggs, dairy products and meats, are susceptible to damage during handling. Additionally, labor availability and wages continue to increase. For these reasons, perishables are increasingly being unitized prior to and/or during shipping. "Unitizing is the process of combining individually packaged products into a larger, stable unit load convenient for handling, shipping, and storage" (Laundrie, 1986. Forest Products Lab Guide). One study cited a 75% savings in labor once unitization was implemented (Cascade Corp., undated).

Unitizing can be implemented at several levels, beginning with packaging. The first level of unitizing begins with individual packaging. For example, after sorting and grading, blueberries are typically weighed into rigid, 'clamshell' packages. These clamshells then move to the second level of unitizing by being packed in a fiberboard carton (or 'flat' in that industry). The third level of unitizing occurs when the cartons are stacked on a pallet (Figure 20). Alternatives to pallets are slip sheets and super (bulk) sacks.

### **STANDARDIZED PALLET SIZE AND CONSTRUCTION**

The standardization of pallet sizes has made handling and shipping more efficient. The most widely used base dimensions in the U.S. are 40 x 48 inches (approximately 100 x 120 centimeters) (Figure 21). Pallets must be fabricated out of a material of sufficient strength to minimize shifting or compression of the palletized product. Hardwood pallets are most common, although plastic and compressed pulp pallets are also utilized. Pallet



**Figure 20.** Blueberries packed in rigid plastic 'clamshell' packages and unitized in fiberboard cartons to be palletized. (Source: S. Sargent)



**Figure 21.** A 4-way pallet fabricated from hardwood. (Source: CHEP International)

standards are available from the National Wood Pallet and Container Assn. ([www.palletcentral.com](http://www.palletcentral.com)). Prior to reuse, the pallets must be inspected, repaired if necessary, and sanitized. Leasing programs incorporate these steps each time a pallet is retrieved. Pallets designed for 4-way entry provide extra flexibility in loading the trailer and superior airflow between the floor of the transit vehicle and the palletized product. For reefer container shipments of respiring cargoes, the pallets should be configured to permit (and not block) vertical airflow through carton vent holes.

## SLIP SHEETS

Slip sheets can be used for some perishables (Figure 22) carried in reefer containers such as freeze cargo and chilled non-respiring items like meat. The slip sheet can be constructed of corrugated fiberboard of sufficient strength or heavy-duty plastic polymers. Slip sheets are less expensive than pallets, are disposable/recyclable (good for one-way shipments), can be used with pallets and can be used multiple times, depending on construction material. However, they require specialized handling equipment, such as a 'push-pull' hydraulic attachment onto the fork lift (Figure 23). There are some disadvantages with slip sheets. To wit, slip sheets restrict airflow under the load and are not recommended in top-air delivery trailers or bottom-air delivery refrigerated containers when carrying fresh produce or other heat-generating items. For truck trailer shipments, slip sheets offer limited if any protection from the radiant road heat and extreme cold ambient conditions.

## PACKAGE DIMENSIONS

It is important to maximize the 'cube' space within the trailer and container. To accomplish this, package dimensions must be designed to completely cover the pallet surface, without overlapping the pallet edges (Table 1).



**Figure 22.** A slip sheet fabricated from fiberboard. (Source: J.K. Brecht)



**Figure 23.** Stacked load on a slip sheet being pulled onto specialized forklift tines for transfer. (Source: Thida Sathorn Co.)

For reefer containers, refrigerated air will “short circuit”, passing through gaps between the pallets instead of passing through the vent openings in the packages if the packages do not cover the entire surface of the pallet. Packages that extend over the pallet edges (due to improper stacking or oversized base dimensions) will fail, crushing the product during subsequent handling (Figure 24).

**Table 1.** Package base dimensions for a standard pallet (40 x 48 inches; 100 x 120 centimeters).

PACKAGES PER LAYER	BASE DIMENSIONS	
	(INCHES)	(CENTIMETERS)
5	24 X 16	60 X 40
6	20 X 16	50 X 40
8	20 X 12	50 X 30
10	16 X 12	40 X 30

The package height is based on the sensitivity of the crop to compression – the more sensitive the crop, the lower the maximum package height. The overall pallet height cannot block the air delivery chute, exceed the transit vehicle load limit red line, or the height of door openings for cold rooms, trailers, and marine containers. See section IV, “Loading (Stowage) Patterns” for more details.

## PACKAGE VENTING

For horizontal and vertical airflow transit vehicles, packages for fresh produce must have adequately sized and aligned vent openings to allow sufficient refrigerated airflow through the respiring product during cooling and

transport. The rule-of-thumb for sufficient vent openings is 5% of the total carton surface area. Vent arrangement in cartons must consider stacking configurations so that the vents align properly – this is particularly critical when cartons are cross-stacked on each layer (Figure 25).

## PACKAGE MATERIALS

Corrugated fiberboard cartons are the most commonly used packages in the domestic and international industry. Cartons must be constructed to official ASTM standards for stacking strength to ensure integrity during handling operations (ASTM, website link: [https://compass.astm.org/EDIT/html\\_annot.cgi?D5639+11\(2015\)](https://compass.astm.org/EDIT/html_annot.cgi?D5639+11(2015))). The vertical corners of packages provide maximum stacking strength; therefore, corner-on-corner stacking configurations are recommended.

When produce is cooled by hydrocooling or package-icing, it must be packed in impermeable packages such as waxed fiberboard cartons. Unwaxed cartons are recyclable, whereas waxed cartons are not. Fiberboard carton manufacturers also supply cartons that are resistant to high humidity (but not free moisture) by incorporating a moisture-resistant layer or applying a moisture-resistant film to inner surfaces.



**Figure 24.** Failure of the bottom cartons due to poor construction or improper stacking. (Source: S. Sargent)



**Figure 25.** Cartons with vent holes designed to align when cross-stacked to allow both horizontal (top-air) and vertical (bottom-air) air flow during transport. (Source: J.K. Brecht)

Returnable Plastic Containers (RPCs) are typically leased from suppliers and are required by some receivers. They incorporate recommended features, such as adequate stacking strength and venting, impermeability to water and recyclability. Following use, they are returned to the supplier where they are inspected for defects, washed and sanitized for reuse.

Wooden wirebound crates are commonly used for some crops that are field packed, such as sweet corn, cabbage and hard squashes. Maximum stacking strength is in the rigid end panels. They are waterproof but are not easily recyclable.

Plastic corrugated cartons are an alternative to waxed, corrugated fiberboard cartons. They are waterproof and recyclable. These cartons must be designed with sufficient stacking strength to protect the crop when palletized. Expanded polystyrene (Styrofoam™) containers are routinely used for export shipments of table grapes and other crops that are air-freighted. The foam provides insulation during breaks in the cold chain.

Bags are used for both bulk and consumer packs. Potatoes and onions are often packed in 50-lb paper bags. These bags may have netting or perforations incorporated on a side panel and should be air-stacked to facilitate ventilation. While keeping the desired weight, the crop itself must be strong enough to bear the weight on the pallet. Smaller bags are fabricated from polyethylene films or netting and are increasingly used for 'grab-and-go' packs for consumer convenience. These bags are packed in a master container for palletizing.

Larger produce items such as watermelons and cantaloupes can be shipped in plastic bins or in corrugated fiberboard bins on pallets. Sized and graded green tomatoes are also shipped in bins for repacking at distant locations. Plastic bins are either of rigid or collapsible construction and height is determined by the sensitivity of the crop: 25 inches or 29 inches are common pallet bin heights.

Super (bulk) sacks made of woven, poly material are widely used for storage of tablestock potatoes, with capacity up to 1000 lbs (454 kg). They are filled from the top, unloaded from the bottom and are transported on pallets (Figure 26). Cooling may not be uniform within the super sack due to limited ventilation. Specialized equipment is required for filling and unloading operations.

## **PALLET STABILIZATION**

Pallet stability is a critical component for successful transport. Shifted loads during shipping can cause major losses in product and rejected loads





**Figure 26.** Potatoes a) stored in a super sack and, b) being unloaded onto the packing line. (Source: S. Sargent)

upon arrival. Several options are available to maintain pallet integrity. For example, corrugated fiberboard cartons containing small fruits typically have a corrugated sheet placed every four or 5 layers to secure the stacked cartons. Pallets are often fitted with corner boards and vertical/horizontal strapping (Figure 27). Lidded cartons may have glue applied to the lids prior to palletizing as an alternative to strapping. Although RPCs interlock when stacked, straps are normally added to maintain integrity. During truck or trailer loading, braces or inflatable air pillows should be added to secure



**Figure 27.** Palletized flats of blueberries with horizontal strapping and corner boards. (Source: A. Berry)

pallets away from sidewalls, ensuring proper air distribution throughout the load during transport. See section IV, “Loading (Stowage) Patterns.”

## TELEMATICS

Telematics, in a broad sense, is the term used to describe the transmission of information related to remote objects over a telecommunication network together with the computerized processing of this information.

There are many practical applications of vehicle telematics, such as: monitoring the location, movements, status, and behavior of a vehicle or fleet of vehicles, trailers, containers, and railcars.

The use of satellite navigation, which combines global positioning system or GPS with an electronic mapping software application, plus the increasing miniaturization and utilization of sensors and cameras enable additional applications such as: vehicle use-based insurance, fuel management, vehicle maintenance, cargo temperature monitoring, theft prevention, and lately self-driving vehicles.

One application with significant impact for maintaining quality and safety of horticultural products is remote temperature management. The ability to remotely monitor the temperature of the refrigeration unit and/or the temperature of the cargo in real time could help minimize the negative effect of temperature outages on the cargo. It could also help a carrier demonstrate to shippers and receivers that it has maintained temperature conditions during the transportation operation consistent with those specified by the shipper.

A typical remote temperature monitoring system (Figure 28) may include at least one temperature sensor, a vehicle-mounted device composed of a microprocessor unit, a GPS, and at least one communications transceiver, which captures and transmit sensor data and location coordinates to a remote computer via one communications network, such as cellular or satellite. The remote computer hosts the software application that allows a remote user to monitor the temperature of the cargo environment and the location of the vehicle.

Some remote temperature management systems provide monitoring as well as controlling capabilities (Figure 29). This is accomplished by remotely accessing the refrigeration unit’s controller using two-way communications and a customized software application to modify the temperature set point based on input received from sensors located in the reefer unit and/or cargo space.

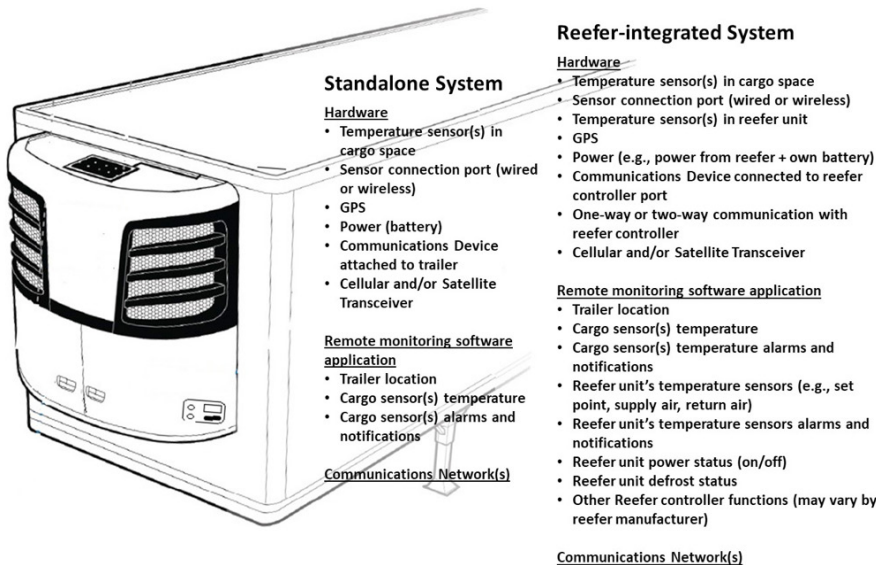

**Figure 28.** Illustration showing commercial remote temperature management system, describing components. (Source: J. Saenz)

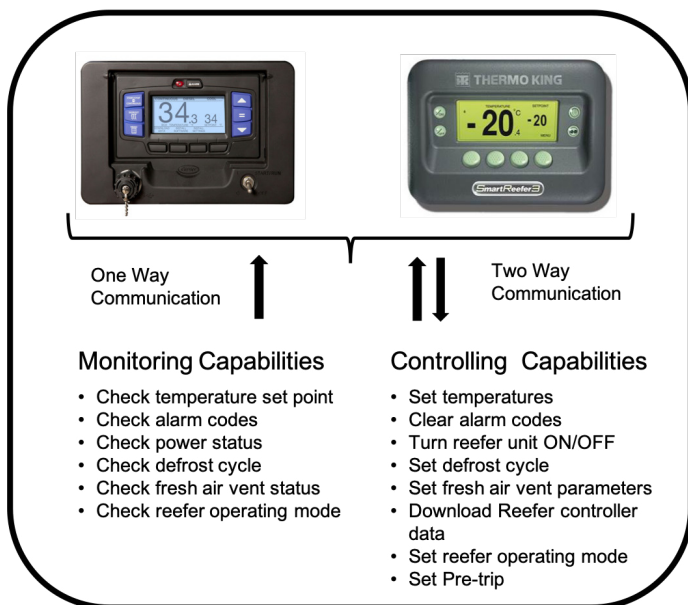

**Figure 29.** Illustration showing commercial remote temperature management system with controlling capabilities. (Source: Adapted from Carrier Transicold and Thermo King online published reefer controller photos)

Nevertheless, the lack of a remote temperature management system must not preclude carriers and shippers from recording and tracking product temperatures. Date-stamped product temperature data are essential for determining root cause, location, and possession in case of cargo losses, as well as for noticing indicators and uncovering evidence that something is developing or changing. For example: a) sudden increases in product temperature due to new packaging, b) accelerated ripening due to changes in harvest maturity, c) increased product temperature variability due to a new crew's loading practices, etc.

It is important to differentiate between sensors placed inside the transport's cargo space from sensors located inside the transport's refrigeration unit. The latter are part of the reefer unit and are used by the reefer's controller to operate the refrigeration equipment and regulate the temperature of the air supplied to the cargo space.

Several published industry studies have illustrated the amount of temperature variability that could exist inside the cargo space of transports carrying horticultural products. There could be many reasons for this, both intrinsic to the horticultural product, such as pre-harvest and harvest conditions and practices, as well as extrinsic to it, such as postharvest, packaging, pre-tripping, precooling, handling, and stowage practices, and refrigerated transport equipment performance (Figure 30).

The above studies utilized multiple wireless temperature recorders placed inside product cartons throughout the cargo space to capture product temperatures during the entire supply chain. They helped identify high-temperature pockets, which have been referred to as 'microenvironments.' A microenvironment may be the environment immediately within or surrounding

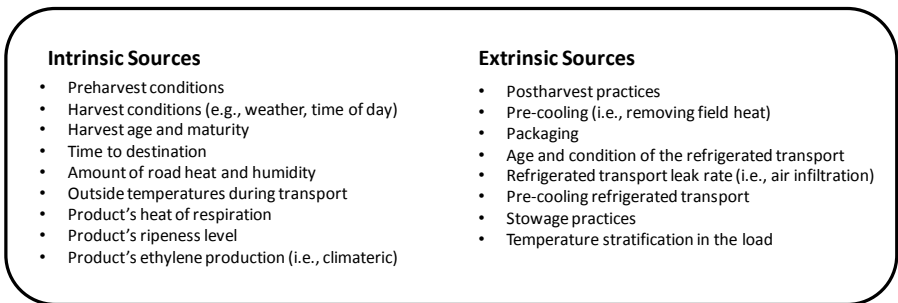

**Figure 30.** Illustration showing sources of variability in temperature and atmosphere distribution for fresh horticultural products. (Source: J. Saenz)

a perishable item, package, carton, cargo, etc. in a localized area inside the cargo space of a reefer or an insulated box.

Microenvironments may be created by the variability in temperature and/ or atmospheric distribution inside the cargo space of refrigerated transport due to many factors, such as but not limited to: leak rate, thermal efficiency, age and condition of the refrigerated transport, insufficient unitization, packaging and stowage of cargo, short cycling of conditioned air, product's field heat and heat of respiration, and condition, age and/or maturity of cargo.

A microenvironment may be a very small, specific area, distinguished from other microenvironments and potentially influenced differently by its immediate surroundings such as the placement and stacking of the cargo within the truck/trailer/container, air infiltration into the truck/trailer/container, the airflow and temperature stratification in the load and other factors, as well as the amount of radiant heat load of the sun, road heat, humidity, rate of speed of the transit vehicle, and/or day/night temperatures.

## **CARGO SPACE MANAGEMENT**

### **TEMPERATURE MANAGEMENT**

#### ***Air Temperature vs. Product Temperature***

It is a common misconception that ambient air temperatures inside refrigerated transport equipment or in the return and supply air registers of the refrigeration unit are the same as the temperatures inside the cartons of product or the internal product ('pulp') temperatures. This assumption is simply not universally correct. Air temperatures in the ambient space outside the cartons of perishable products change more quickly than internal product temperatures or the temperatures inside the cartons. More importantly, decisions to reject perishable products are often based on air temperatures recorded in the air space outside cartons and not inside cartons of product, thereby resulting in unwarranted rejections of perishable food shipments.

By way of affirmation, in-transit trials have demonstrated that perishable foods have been mistakenly rejected because recorders placed outside of the cartons were recording "warm" air temperatures when, in fact, the temperatures recorded inside the cartons were perfectly normal. It follows that recorders should be placed inside the cartons for more representative and defensible product temperatures.

- Cargo at desired shipping temperature at the time of loading
- Temperature settings are specific for each type of product

## CHILLING AND FREEZING INJURY

Chilling injury is a physiological disorder of fresh fruits and vegetables that negatively affects their normal physiology. Susceptible fruits and vegetables are subject to chilling injury at temperatures usually below about 59°F (15°C) but above 32°F (0°C). For each type of fruit and vegetable, there is a characteristic chilling threshold temperature, below which injury may occur. The symptoms of chilling injury often develop only after the commodities have been returned to warmer temperatures for marketing and in consumers' homes. Chilling injury symptoms are specific to each commodity and may include pitting, external or internal discoloration, off-flavors, abnormal or lack of ripening, and increased decay.

Chilling injury severity varies with both time and temperature such that the injury occurs more quickly the lower the temperature. Some commodities, such as bananas, will be injured by just a few hours' exposure to chilling temperatures. Others can be held below the chilling threshold temperature for several days and recover without incurring serious injury when returned to a non-chilling temperature. Table 2 lists some of the major fresh produce items that are most susceptible to chilling injury when transported below recommended temperatures. Refer to section V, "Individual Commodity Requirements," for information on freezing and chilling of individual commodities.

**Table 2.** Approximate lowest safe temperatures during transport for some fruits and vegetables subject to chilling injury.

COMMODITY	APPROXIMATE LOWEST SAFE TEMPERATURE <sup>1</sup>	
	°F	°C
Asparagus	36	2.2
Avocados, cold-tolerant (e.g., Hass)	40	4.4
Avocados, cold-sensitive (West Indies types)	55	12.8
Bananas	55	12.8
Beans, green or snap	41	5.0
Carambola (starfruit)	41	5.0
Chayote	45	7.2
Cucumbers	45	7.2

<sup>1</sup>Chilling injury may vary considerably by cultivar, harvest season, exposure time, commodity maturity, and temperature history prior to transport.

COMMODITY	APPROXIMATE LOWEST SAFE TEMPERATURE <sup>1</sup>	
	°F	°C
Eggplants	45	7.2
Ginger	45	7.2
Grapefruit	50	10.0
Guava	40	4.4
Jicama	55	12.8
Lemons	50	10.0
Limes	50	10.0
Litchi or lychee	38	3.3
Mandarins (tangerines)	41	5.0
Mangoes	54	12.2
Mangosteens	50	10.0
Melons		
Cantaloupes	36	2.2
Honeydews, Casabas, Crenshaws, Persians	45	7.2
Watermelons	50	10.0
Okra	45	7.2
Oranges (grown in California or Arizona)	38	3.3
Passionfruit	45	7.2
Peppers, bell or sweet	45	7.2
Pineapples	45	7.2
Pitaya (dragon fruit)	45	7.2
Potatoes		
Table stock	38	3.3
Chipping	50	10.0
Pomegranates	41	5.0
Pumpkins and hard or winter squashes	50	10.0
Rambutan	46	7.8

<sup>1</sup>Chilling injury may vary considerably by cultivar, harvest season, exposure time, commodity maturity, and temperature history prior to transport.

COMMODITY	APPROXIMATE LOWEST SAFE TEMPERATURE <sup>1</sup>	
	°F	°C
Squash, soft, summer or zucchini	41	5.0
Sweetpotatoes	55	12.8
Tomatoes	55	12.8
<sup>1</sup> Chilling injury may vary considerably by cultivar, harvest season, exposure time, commodity maturity, and temperature history prior to transport.		

Trucks transporting perishables through areas with outside temperatures much lower than 32°F (0°C) may need to be warmed rather than refrigerated to prevent freezing or chilling injury. Product freezing also may occur if the thermostat setting and/or low temperature floor limit are too low, particularly on the top layer of trailers, the rear of the trailer when a ceiling air chute is installed, and the bottom layer of marine containers, where the coldest air exits the refrigeration unit. Chilling and freezing tend to occur in characteristic patterns within the load. The most serious chilling and freezing occur in the product that is exposed to the coldest air or is nearest to the walls and floor when the outside temperatures are extremely low. Sensitive products should not be allowed to directly contact the trailer or container walls or floor in order to avoid excessive heat transmission to the outside environment.

Unintended freezing of fresh animal and plant food products during transport results in ice formation that disrupts the cellular integrity of the tissue, which is especially evident after thawing. Freezing injury of fresh fruits and vegetables results in a water-soaked appearance and mushy texture upon thawing. Eggs may crack and incur irreversible physical changes from freezing. The texture of some cheeses are changed by freezing.

Freezing losses are most common in fruits and vegetables such as apples, celery, and lettuce that normally move at temperatures near their freezing point. The extent of injury varies with the characteristics of the product, the severity of freezing, and the location of the product within the load. Commodities such as beets and cabbage can withstand light freezing and thawing several times without permanent injury. Other products such as potatoes and tomatoes are permanently injured by only one slight freezing. Table 3 groups certain fruits and vegetables by their sensitivity to freezing injury.



**Table 3.** Sensitivity of some fruits and vegetables to freezing.

<b>MOST SENSITIVE<sup>1</sup></b>	<b>MODERATELY SENSITIVE<sup>2</sup></b>	<b>LEAST SENSITIVE<sup>3</sup></b>
Asparagus Avocados Bananas Beans, green or snap Berries (except cranberries) Cucumbers Eggplants Lemons Lettuce Limes Nectarines Okra Peaches Peppers, bell or sweet Plums Potatoes Squash, summer Sweetpotatoes Tomatoes	Broccoli Cabbage, early or new Carrots Cauliflower Celery Cranberries Grapefruit Grapes Onion, dry Oranges Parsley Pears Peas Radishes Spinach Squash, winter	Brussels sprouts Cabbage, late season Collards Dates Horseradish Kale Kohlrabi Parsnips Rutabagas Salsify Turnips
<sup>1</sup> Commodities likely to suffer injury by one light freezing. <sup>2</sup> Commodities likely to recover from one or two one light freezings. <sup>3</sup> Commodities that can be lightly frozen several times without sustaining serious damage.		

**THAWING OF FROZEN FOODS**

Frozen foods are typically frozen quickly in a blast freezer or individually quick frozen (IQF) to 0°F (-18°C) or below; chemical, biochemical, and physical processes leading to irreversible quality changes can occur at temperatures above 0°F (-18°C). The higher the freezing temperature above 0°F (-18°C), the greater the rate of deterioration of the frozen foods. Extremely low temperatures can extend shelf life and are not detrimental to properly packaged frozen foods. A fast freezing rate provides more desirable product quality because of the small ice crystals formed. Freezing food slowly will form large ice crystals that can damage the cellular structure of frozen meats and causes changes in texture of meat foods and frozen dairy products. Unintended thawing of frozen foods is typically a slow process and has the same negative effects as slow freezing.

Even though microorganisms do not grow at 0°F (-18°C), certain microorganisms can develop at temperatures around 20°F (-7°C) and above, adding to deterioration and contamination of the food. If present, microorganisms can multiply rapidly when frozen foods are thawed. This in turn causes off-flavors. The by-products of microbial growth on meat, for instance, will cause chemical changes within the meat, such as oxidation and off-flavors.

When food on pallets is frozen, the pallets are stacked to provide air flow between tiers and layers of cases to allow freezing to occur as quickly as possible. In transit, pallets of frozen products are stacked tightly for efficiency, but this is completely unsatisfactory for freezing purposes. So, if loads of frozen food thaw, re-freezing is slow and results in loss of quality.

Since heat moves toward a cold source, during very cold weather the heat from fresh products loaded against the walls and floor in a unit can move outward, reducing the product temperature below that which is desired. The opposite effect occurs during very hot weather and may result in heating and thawing of products along the walls and floor. The best methods of preventing this heat loss or gain and subsequent potential chilling, freezing or thawing damage are:

- reducing the amount of surface contact of the product with the floor and walls; and
- circulating interior air around the perimeter of the load.

Various loading methods may be used to reduce product contact with the walls and floor. For example, the offset-by-layers loading pattern reduces carton contact with the walls by about 50% and also provides ducts for air to circulate along the length of the wall (Figure 31a). Hand-stacked loads of bagged products can be pyramid stacked (Figure 31b). Palletized loads keep product from contacting floors, but should be center-loaded and braced away from the walls (Figure 31c).

Enhance perimeter air circulation by using high airflow or deep T-rail floors (Figure 32). If the vehicle is not equipped with deep channeled floors, use pallets or disposable wooden floor racks to prevent contact of the product with the floor and for more space for the warmed air to circulate under the load. Ribbed or vertically grooved walls will allow increased air circulation down the walls and reduce surface contact with the product.

**(A) CROSSWISE - OFFSET STACK**

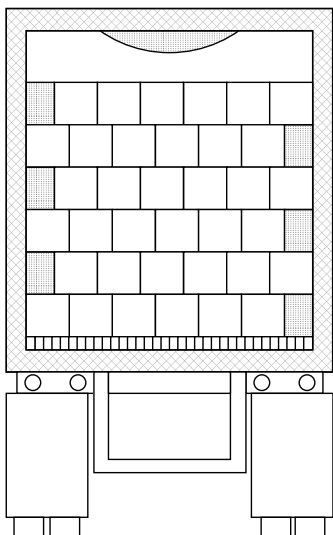

**(B) PYRAMID STACK**

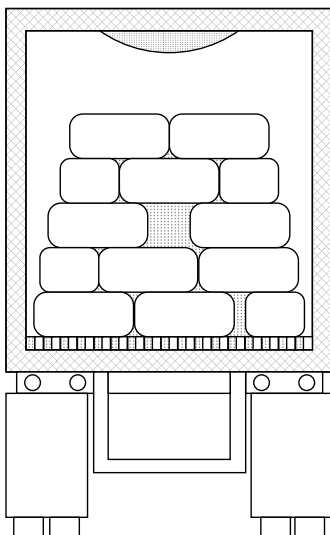

**(C) CENTER - LOADED**

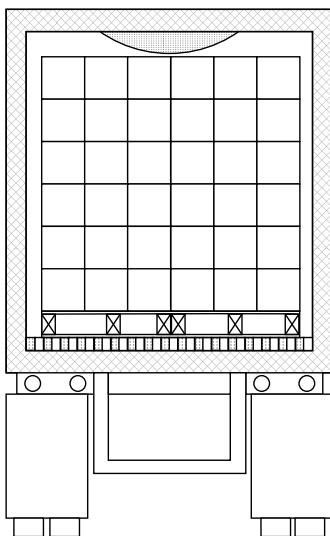

**Figure 31.** Methods of loading to reduce contact of products with walls and to reduce the chance of freezing or chilling injury in extremely cold weather: (a) crosswise offset stacking of boxes or crates, (b) pyramid stacking of bagged products, and (c) center-loading of palletized loads.

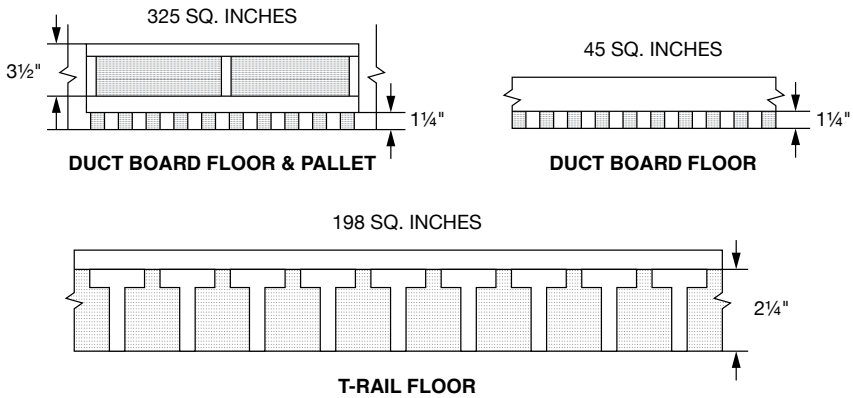

**Figure 32.** Effect of different floor configurations on return air space under the load.

## ATMOSPHERE MANAGEMENT

Atmosphere management usually refers to controlled or modified atmosphere (CA and MA) systems that manage the nitrogen (N<sub>2</sub>), oxygen (O<sub>2</sub>), and carbon dioxide (CO<sub>2</sub>) and a few other gases like ethylene and carbon monoxide in a storage or transport environment as a supplement to temperature management for fresh produce. Humidity management is usually considered separately from atmosphere management systems.

MA differs from CA only in how precisely the gas partial pressures are controlled. CA is more precise than MA in that CA systems employ feedback control of the gas concentrations. A CA is attained when concentrations of gases making up the atmosphere in a vehicle are constantly replenished to maintain predetermined levels. In MA, gas concentrations are initially modified to meet specific product criteria, but not consistently replenished in transit to maintain the initial levels.

Truck trailers are rarely equipped with CA management subsystems. Such systems are usually found in multi-modal reefer containers, which may be transferred from ocean vessels to flatbed trailers to be carried over the road. Truck trailers use MA systems that may involve creating an MA in the entire trailer or within individual pallets or packages ('modified atmosphere packaging' or MAP). MAP is commonly used for fresh meat and seafood as well as for produce.

Nearly every product, and sometimes each variety, has a different combination of gases in which it keeps best during storage. An atmosphere that improves the keeping qualities of one product may have an adverse

effect on another. Temperature and humidity modify the effects of CA and MA. For these reasons, consult Appendix II of this handbook and information on individual commodities in the USDA Handbook No. 66 (see Selected Bibliography) before applying CA or MA to a product load. However, the optimum CA for each product also varies according to the storage (transit) period, which means that better results may be obtained by using an atmosphere that differs from what research has determined to be the best for the longest possible storage of that product.

### FRESH AIR EXCHANGE

Reefer containers have manually adjustable fresh air exchange ports. The fresh air exchange can be set to manage the amount of outside air that is allowed to passively enter and leave the container through the vent ports. The purpose of manual fresh air exchange is to protect fruits and vegetables from injurious levels of  $O_2$ ,  $CO_2$  and/or  $C_2H_4$  that may develop in the interior of reefer containers due to respiration and  $C_2H_4$  production by the produce. These fresh air exchange systems are designed to replenish  $O_2$  and remove  $CO_2$ ,  $C_2H_4$ , and trace volatiles from the cargo space. Most shippers have guidelines for fresh air exchange settings for individual commodities. Figure 33 illustrates a manual fresh air exchange system.

Automated fresh air exchange systems utilize mechanical ventilation of the container to control the accumulation of  $CO_2$  and depletion of  $O_2$ . Once the maximum  $CO_2$  or minimum  $O_2$  set point is sensed, the system

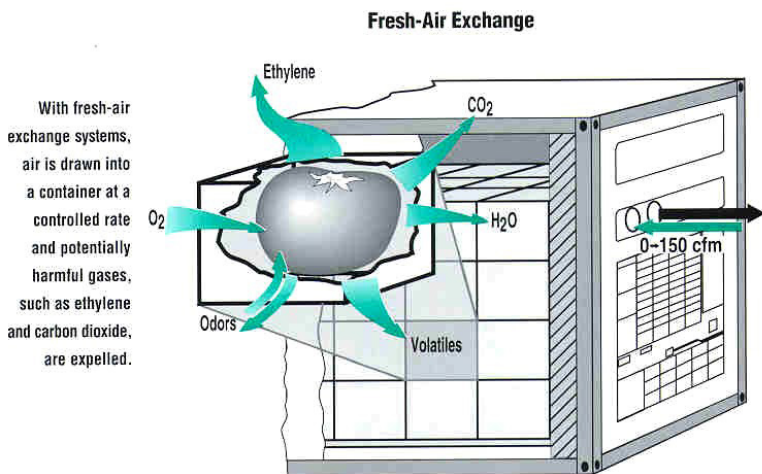

**Figure 33.** Diagram illustrating Manual Fresh Air Exchange. (Source: Brecht, P.E., 1992, Shipping Special Commodities. American President Lines, Oakland, CA.)

opens the mechanized fresh air exchange port, which is controlled by the system's microprocessor controller. Outside ambient air is drawn into the container, thereby replenishing  $O_2$  and diluting excess  $CO_2$ . Automated fresh air exchange systems depend on ambient atmospheres (normal air) and produce respiration to achieve a CA. Since fruits and vegetables typically respire equal amounts of  $O_2$  and  $CO_2$ , the potential atmosphere combinations that can be achieved inside the container with an automated fresh air exchange system are limited.

## **CONTROLLED AND MODIFIED ATMOSPHERE SYSTEMS**

MA systems involve sealing the trailer or container so that it can maintain an MA, then flushing the cargo space with the desired gases. A purge port is used after loading and sealing the trailer or container to flush it with a beneficial mixture of  $N_2$  and  $CO_2$ . The gas environment in MA-equipped reefer containers typically changes during transit due to the changing respiratory activity of the produce, the performance of  $CO_2$  and  $C_2H_4$  scrubbers, if used, and the leak rate of the container. Since there is no control of the atmospheric gases in an MA system, the  $O_2$  and  $CO_2$  concentrations are merely maintained within an acceptable range during transit. However, MA is a less costly investment and operating alternative than CA.

Marine containers are typically more gas tight than truck trailers. Sealing a trailer tightly enough to hold the desired concentrations of gases during transit is a major problem in MA truck shipments. A more common practice is to apply a plastic film curtain sealed to a curtain track around the inside of the rear doorway before closing the loaded trailer. In some cases, a large plastic bag enclosing the entire cargo space is inserted in the trailer, the product is loaded inside the bag, the bag is sealed, and the desired atmosphere is injected. For transit periods of more than several days, vehicles containing a modified atmosphere may need to be recharged with gas en route.

For both truckload and less than truckload lots, individual pallet loads of the product are sealed in plastic bags, the air evacuated, and a MA injected. The preparation of vehicles or pallet loads for MA shipments is usually done by companies specializing in this trade. They also market the applicable gases, usually under a registered trademark. In some cases, they provide services for monitoring and recharging the atmospheres in transit.

Strawberries are the product most commonly shipped over the road in MA, using a plastic pallet shroud to contain the MA.  $CO_2$  gas is a basic component in the atmospheres for berries, other small fruit, and cherry shipments, because it is a mold retardant. Increasing  $N_2$  gas to reduce  $O_2$

levels usually is a basic component for green leafy produce since CO<sub>2</sub> gas may cause discoloration of these products. Reducing O<sub>2</sub> levels retards the produce aging, ripening, and decay that take place in normal air. Extremely high or disproportionate levels of any gas may result in product discoloration and off-flavors.

CA systems found in reefer containers may be integrated into the microprocessor-controlled refrigeration systems or they may be transferable between containers. The former type of CA system is described as ‘active’ because it both establishes and maintains the CA, while the latter systems are considered as ‘passive’ because they only maintain the atmosphere after it has been established by gas purging the container. After the atmosphere is established, O<sub>2</sub> and CO<sub>2</sub> sensors are used to monitor the gas levels; the O<sub>2</sub> consumed in respiration is replenished by injection of air and the excess CO<sub>2</sub> produced in respiration is removed via scrubbing with a CO<sub>2</sub> absorbent or by diffusion through a semipermeable membrane. If CO<sub>2</sub> accumulation is insufficient to achieve the desired level, some CA systems carry compressed CO<sub>2</sub> gas that can be injected into the cargo space.

In all MA and CA systems, scrubbers may be placed into the cargo space to remove C<sub>2</sub>H<sub>4</sub> from the atmosphere.

## HUMIDIFICATION AND DEHUMIDIFICATION SYSTEMS

### SOURCES OF HUMIDITY

Water vapor enters the transit vehicle through the fresh air exchange ports, leaks in the transit vehicle, and water loss from the cargo.

During transport, ambient temperatures can exceed the setpoint temperature. The table below makes it clear that excessive fresh air exchange settings at elevated ambient temperatures will cause an excessive amount of water intake into the reefer unit. (Table 4).

The maximum amount of water vapor in air increases exponentially with temperature. In maritime climates, the usual water vapor content of ambient air is close to its maximum: the saturation limit.

**Table 4.** Maximum amount of water vapor in ambient air.

<b>AMBIENT TEMPERATURE (°C/°F)</b>	<b>-15/5</b>	<b>0/32</b>	<b>15/59</b>	<b>30/86</b>
Maximum water vapor content (g/kg air)	1.2	3.8	10.5	26.2

The proper humidity or moisture content of the air surrounding fresh fruits and vegetables helps maintain quality during transport. Most perishable horticultural products require high relative humidities of 85% to 95% to prevent dehydration and to keep them fresh and crisp.

Relative humidity, as used in this handbook, is the percentage of water vapor in the air in relation to the saturation point of the air at a given temperature.

## **HUMIDITY MAINTENANCE**

With regard to elevated humidity within the cargo space, the design of the refrigeration system and control algorithms are routinely able to maintain elevated humidity levels in excess of 85%. Most transport refrigeration equipment has humidity monitoring capabilities. Humidification may be integrated into a CA system that involves direct injection of dry gases to avoid dehydration of fresh produce. Otherwise, refrigerated transport equipment systems are rarely equipped with subsystems capable of adding moisture to the cargo space due to food safety concerns that the water may be a vehicle for spreading pathogenic and/or spoilage microorganisms throughout a load.

Product moisture loss during transit can be minimized by the following practices:

- Using package ice (such as for fresh broccoli and green onions), although this practice is becoming less common due to food safety concerns related to free water;
- Precooling the cargo thoroughly to reduce the temperature differential between the product and the surrounding air;
- Keeping the refrigeration coil only a few degrees colder than the desired transit temperature; and
- Waxing the product or using semi-permeable plastic wraps to reduce evaporation.

Adding top ice to trailer and container loads of produce, as has traditionally been done for products like broccoli and sweet corn, is no longer recommended due to food safety risks associated with the presence of free water. The same applies to use of supplemental humidification systems that spray water to increase humidity.

## **DEHUMIDIFICATION**

Dehumidification is based on the physical principle of condensing moisture out of humid air by using the cold surface of the reefer unit's evaporator coil. When the reefer unit is running, the evaporator lowers the temperature of the air moving through it. The lowering of the air temperature causes water vapor



to condense on the evaporator coil. Depending on the setpoint temperature, the condensate may be liquid or an ice layer. The result of this process is dehumidified air.

Most reefer containers have a dehumidification option controlled by an algorithm in the microprocessor to remove additional moisture via the refrigeration system. Truck trailers and railcars typically do not feature a dehumidification option. This option is only beneficial to a few products that benefit from a reduced humidity environment (50-70% RH) such as onions, garlic, and selected flower bulbs. For the vast majority of perishable products, the dehumidification option should be turned 'off'; low relative humidity can have a negative effect on the condition (quality) of most perishable commodities.

---

## II. Preparation for Loading

Preparation for loading is an important step in putting together a successful shipment. When developing and implementing a good preloading plan, consider the following factors:

### PRODUCT TEMPERATURES AND TOLERANCES

Perishable foods must be maintained within specific, narrow temperature ranges during all stages of handling, including transportation, to ensure that their quality and safety are not compromised. These stages can be thought of as links in a chain, hence the term 'maintaining the cold chain' is often used. The idea is that a chain is only as strong as its weakest link, and breaking a link compromises the entire chain. The optimum storage and handling temperature for each individual type of food has been determined based on what is required to minimize loss of the unique qualities possessed by that food.

Brief deviations from the optimum temperature may be tolerated by some of the less perishable types of food during transportation, but typically temperatures should be maintained within very tight tolerances to avoid loss of quality. Temperatures either above or below the optimum may be potentially damaging depending on the type of food product. Some transportation refrigeration manufacturers, mainly in the interest of energy savings, offer programmable features that allow a setpoint temperature range to be used. Caution should be exercised in using these features, as the temperature ranges for individual products may not have been rigorously tested.

There is always some amount of temperature variation of the product in a trailer, container or railcar. This variability may be due to outside heat energy not being evenly distributed. For example, in the northern hemisphere, radiant heat from the sun is greatest on the southern exposure; road heat is greatest on the floor, as well as the fact that conditioned air is always coldest at the point of discharge from the reefer and warms as it picks up heat while moving around and through the load to return to the reefer. For fresh produce, which produces heat in the process of respiration, temperatures may rise in the center of the load if loading patterns or poorly vented cartons restrict the circulation of conditioned air. The ability of a transport refrigeration system to maintain uniform temperatures is dependent on product temperature at the time of loading, loading pattern, refrigeration capacity, fan speed and fan capacity, bulkhead design, delivery chute (for top-air systems), use of pallets, and floor and wall fluting.

For produce, it is recommended that three portable temperature recorders (see, “Temperature Recording and Tracking” in section II, “Preparation for Loading”) be placed within pallets at 1) the front and 2) the middle of the load, and 3) on the outside rear face of one of the rearmost pallets (not on the wall). The front location detects short cycling of refrigerated air; the middle is where product heating is most likely to occur; and the rear location is to record the air temperature at the farthest point from the reefer unit. Note: Placing recorders on walls may result in elevated readings that do not accurately reflect the temperature in the load space.

Unplanned temperature ‘excursions’ may occur during transport, as with a loss of power situation. In such cases, the potential for loss of quality or damage to the product being carried depends on the duration of the excursion and the outside environmental conditions. Product temperatures always lag behind changes in air temperature, and changes in product temperature do not occur uniformly – heating of non-respiring products advances from the outermost surfaces to the innermost regions, while respiring products (i.e., produce) may heat from the inside out. How quickly the return air temperature stabilizes after power restoration may be diagnostic in determining the potential negative effect of a temperature excursion on product quality, as it is suggestive of how much product heating occurred.

Before loading and unloading transport vehicles, manually measure the cargo temperature to ensure that it is at the shipper-specified carrying temperature. This is usually done with a probe thermometer. Only the tip of the probe detects temperature, but readings may be influenced by the stem of the probe, which must be equilibrated with the temperature of the

product. The best practice is to measure one item of food to equilibrate the probe temperature, then measure and record the temperature of a second item. Insert the probe tip about one-third of the distance to the item center to measure the mass-average temperature. Wait at least 15 seconds for the reading to steady before recording the reading. Thermometers should be recalibrated regularly by measuring the temperature of an ice-water slurry, which is 32.0°F (0.0°C).

An infrared (IR) thermometer is a device that can be used to measure the temperature of a surface without contact. Although this non-intrusive measurement is appealing for certain applications, it's important for the user to understand the operation and limitations of the IR thermometer before using it. Reading accuracy can vary based on the measured area, which increases with increasing distance from the object being measured, or when attempting to measure temperature through glass or plastic film. An IR thermometer cannot be used to check air temperatures or the internal temperature of a perishable product, and it may not function properly if it is subject to abrupt temperature changes, like when opening the transport vehicle doors. Also, accurate readings with IR thermometers can be obtained only if their emissivity adjustment can be set to the correct emissivity of the material to be measured. (Emissivity is a measure of a surface's ability to radiate heat.) Adjustable instruments come with a chart listing emissivity values for common materials. If a unit is not adjustable, then it is often factory set for an emissivity of biological materials.

## **ADEQUACY OF EQUIPMENT**

The transportation unit's refrigeration system should be operating properly and have the capacity to maintain the proper temperature of the intended product load. If the vehicle is NPLA/RTF certified, the refrigeration unit and insulation rating can be found on performance plates or decals attached at various locations. These decals also provide information on optional equipment on the trailer that affects refrigeration performance, such as bulkheads and air chutes.

U.S. semi-trailer manufacturers may use Truck Trailer Manufacturers Association Recommended Practice R.P. No. 38 Method for Testing and Rating Heat Transmission of Controlled Temperature Vehicles/Domestic Containers and/or Recommended Practice, RP 718A Refrigerated Transportation Foundation Method for Classification of Controlled Temperature Vehicles including domestic containers, in the American Trucking Associations Technology and Maintenance Council's 2014-2015 Recommended Practices Manual. [Reference: Technology Assessment:

Transport Refrigerators. CA Air Resources Board. 2015. [https://www.arb.ca.gov/msprog/tech/techreport/tru\\_07292015.pdf](https://www.arb.ca.gov/msprog/tech/techreport/tru_07292015.pdf). TMC. Technology and Maintenance Council, American Trucking Association. Recommended Practice, RP 718B(T). 2013.].

The 26 members of the European Union (EU), and 23 other European, former Soviet Union, North African, and Middle Eastern countries have signed on as contracting parties to the United Nations Economic Commission for Europe's (UNECE) standards under the Agreement on the International Carriage of Perishable Foodstuffs and on Special Equipment to be Used on Such Carriage (ATP). ATP requires testing and certification of the insulation and cooling capacity of refrigerated transport equipment, and provides for separate testing of TRUs. France, Italy, Russia, and Spain apply ATP standards to domestic transportation within their borders. Although the United States is a contracting party to ATP, the United States made a declaration under article 10, resulting in ATP standards being voluntary in the United States. [Reference: Technology Assessment: Transport Refrigerators. CA Air Resources Board. 2015. [https://www.arb.ca.gov/msprog/tech/techreport/tru\\_07292015.pdf](https://www.arb.ca.gov/msprog/tech/techreport/tru_07292015.pdf). Brian McGregor, U.S. Department of Agriculture. Personal communication (telephone conference call) with Brian McGregor and Rodney Hill, of ARB's Transportation and Toxics Division; May 4, 2015.]

## **EXPERT SYSTEMS**

Expert systems are computer programs residing in the refrigeration system's microprocessor that are designed to automate decision-making during transportation operations. They are based on the expertise of experts in such areas as commodity requirements, transportation engineering, and food safety and sanitary transportation programs. Using multi-functional sensing devices to capture information about cargo conditions, the expert system establishes settings and limits for specific types of food with unique transportation requirements. Expert systems can take complex commodity and food safety related decision-making out of the hands of the operator and others by utilizing the expertise of engineers, scientists, and food safety experts to assist the carrier in setting up custom-tailored computerized systems in response to shipper and FDA-specified requirements for the safe and sanitary transport of food. Besides food safety and commodity settings, expert systems can also be used to control such things as in-transit ripening and pest management treatments.

## CLEANING AND SANITATION

Clean and sanitize the vehicle. Cleaning and sanitizing prevent bacterial, chemical, and odor contamination of food product loads. Remove all loose debris and wash or sweep the floors clean. The floor drains and grooves should be free of debris so drainage will not be blocked. Cleanliness includes visual, chemical, and microbiological aspects.

1. **Physically Clean:** All surfaces are clean to visual inspection.
2. **Chemically Clean:** All surfaces are free of residue on which microorganisms can grow.
3. **Microbiologically Clean:** The surfaces are completely free of any viable microorganisms.

Certain cleaning procedures may be required by law in cases where a meat product may become contaminated by direct or indirect contact with the interior surfaces of the vehicle. Also, certain cleaning laws may apply due to previously hauled cargo, such as chemical residues or municipal wastes. (See also section VI, "Regulatory Considerations for Truck Construction Materials, Cleaning Compounds, and Sanitation.")

Fatty or oily food products, such as butter, oleomargarine, and meats, are highly susceptible to contamination by strong odors. Fresh fruit, such as apples and bananas, also easily absorb strong odors. Thorough cleaning and airing of vehicles previously used for hauling fish, cabbage, and other odorous products are necessary. Leaving freshly opened cans of ground coffee for 8 hours or more in a closed vehicle may be helpful in absorbing odors. The grounds may be spread over the floor and then swept clean before loading. Truckers should refrain from transporting products leaving strong residual odors if they plan to haul fresh meats or other odor-absorbing products soon after.

The best practice when visible residue on transportation equipment or cargo cannot be immediately identified is to treat it as hazardous until proven otherwise. A sample should be taken for analysis. The sampling should be done in a controlled manner, by an authorized person wearing appropriate personal protective equipment such as respiratory protective equipment and impervious gloves. Once the residue is identified, a cleaning contractor should be appointed who has the experience and facilities for the proper cleaning and disposal of the residue. Residue may include products of equipment corrosion like white powder deposits (aluminum oxide/hydroxide), which can be removed by washing the equipment with heated fresh water or neutral pH cleaning solution with no corrosive cleaning agents. Moisture when mixed with some fumigants facilitates oxidation of the aluminum alloys.

For example, sulfur dioxide (SO<sub>2</sub>) used to fumigate grapes during transport is an intermediate in the production of corrosive sulfuric acid. Ozone is also corrosive to metals, rubbers, and plastics used in trailers and containers.

A suggested procedure for cleaning the interiors of trailers and containers is to spray pressurized (2000-2500 psi) hot water of at least 180°F (82°C) without a corrosive cleansing solution. Begin with the ceiling and work down the walls. Front bulkheads should be periodically removed to expose the refrigeration equipment for cleaning. Care must be taken not to damage evaporator coil fins, electrical connections and thermal tape with the pressurized stream. During and after washing the equipment, the trailer or container it should be parked so the rear (door end) slopes downwards to allow complete draining. The interior of the trailer or container should be dry before the rear doors are closed. The floor drains should always be thoroughly cleaned of all debris prior to and after washing the trailer or container. Refer to company policies and equipment manufacturer's guidelines for the cleaning methodologies and the intervals of cleaning.

The FDA Sanitary Transportation of Human and Animal Food (STF) rule requires that the design of vehicles and transportation equipment used in transportation operations, the materials used in their manufacture, and their workmanship be suitable and that they be adequately cleanable. The STF assigns primary responsibility on shippers for outlining requirements for the sanitary transport of food. This includes documenting the required procedures expected -- unless the carrier has entered into a written agreement with the shipper to assume this responsibility. The written procedures must cover cleaning, sanitizing, and inspecting the equipment. Factors that need to be considered include: 1) how the vehicle/equipment is being used; and, 2) the production stage of the food being transported (raw vs. finished product; open vs. closed container).

All parties involved in food transport (carriers, loaders, and receivers) need to clearly communicate with each other regarding their capabilities, to clarify expectations, ensure requirements are attainable, and agree to the actions. The final FDA STF rule requires that shippers and carriers retain records of written agreements and the written procedures as well as employee training records for a period of 12 months beyond when the agreements and procedures are in use or the employee stops performing the duties for which they were trained.

Verification of trailer cleaning and sanitation should be conducted prior to loading cargo. An inspection for cleanliness should also be part of load acceptance procedures. The latter should include an assessment of odors, product leakage, and damage to containers that may occur during transport.

A Trailer Inspection Checklist from the Global Cold Chain Alliance (GCCA) is provided below (Table 5).

**Table 5.** Trailer inspection checklist. (Source: Global Cold Chain Alliance (GCCA); Refrigerated Transportation Best Practices Guide, 2016)

<b>CRITICAL INFORMATION:</b>			
<b>Facility Information:</b>	Shipper:		
	Bill of Lading Number:		
	Unit Number:		
	Ship Date:		
	Ship To:		
	Inspector:		
	Today's Date:		
<b>Vehicle Information:</b>	Trucking Line:		
	Driver's Name (Optional):		
	Trailer License Number (Optional):		
	Trailer Number:		
	License Plat (State):		
<b>TRAILER OR CONTAINER INSPECTION CHECKLIST:</b>			
<b>Area</b>	<b>Item</b>	<b>Satisfactory Condition</b>	
		<b>Yes</b>	<b>No</b>
<b>Refrigeration Unit</b>	Refrigerator Thermostat Properly Set		
	Refrigerator Unit Temperature Setting (Degree F)	Degrees	
	Refrigerator Unit Operational		
	Vents Closed/Open		
<b>Cleanliness</b>	Overall Trailer Condition		
	Floors Free of Rubbish, Product Residue or Insects		
	Walls Free of Product Residue and Tape		
	Drains Open & Unobstructed (Free Flowing)		
	Absence of Odor(s)		
<b>Condition</b>	Ceiling Undamaged		
	Air Delivery Chute Intact & Functional		
	Door Seals Intact & in Good Repair		
	Door Undamaged		
	Walls & Wall Insulation Undamaged		
	Floors in Good Repair		
<b>FINAL RESULT:</b>	SATISFACTORY FOR LOADING		
<b>COMMENTS:</b>			

Proper temperature management supports cleaning and sanitation practices to ensure safe food transport by limiting opportunities for food poisoning organisms to proliferate.

## **VEHICLE PREPARATION AND MAINTENANCE**

Transport equipment must be properly and regularly maintained. Maintenance includes both physical and sanitary conditions suitable for food transport. A regular maintenance program that keeps a refrigerated truck in good repair improves its ability to maintain desired product temperatures during transit. In the long run, maintenance and repairs are less costly than claims and lost maintenance revenue from delivery of products in poor condition.

Rough or splintered sidewalls and protruding nails or screws can tear packages and damage the commodity. Cracked wall liners provide lodging points for dirt and old food particles, which encourage microbial and insect infestation. Walls punctured by forklifts or broken at the seams allow moisture to penetrate the insulation and reduce its effectiveness.

Check door seals and floor drain caps regularly and repair or replace as needed. The mashed-end rubber caps on floor drains tend to clog with debris, and wash crews sometimes cut them off. All seals should be maintained. Dirt and air are sucked into open spaces left by worn and missing seals and drain caps. This adds to refrigeration loads and product contamination.

Keep air chutes or ducts in place and free of holes. The ducts are designed to distribute air so that the load is uniformly cooled. Defective or missing ducts will result in air short-cycling back to the refrigeration unit over the top of the load. This often causes freezing on the top layer and hot spots in the lower layers.

The refrigeration equipment must be checked to ensure that it is in good working order, able to maintain the desired temperature set point within desired limits. Before loading a vehicle, always run the refrigeration unit in high-speed cool for at least 20 minutes and perform an automatic Pre-Trip if that feature is available. The unit **MUST** pass the Pre-Trip test. If it doesn't, follow your company's prescribed procedures.

Check that the bulkhead is functioning properly. Initiate a manual defrost cycle to remove any frost or ice from the evaporator coil and to help ensure maximum cooling performance after defrost is completed. Transport refrigeration units should always be operated in accordance with



the manufacturer's refrigeration unit operating manual, as settings and equipment performance characteristics may and do vary from manufacturer to manufacturer. It's imperative to follow specified refrigeration unit operating procedures when transporting refrigerated cargo.

## PRECOOLING THE PRODUCT AND EQUIPMENT

### PRECOOLING (OR PREWARMING) THE VEHICLE

Trailers should be precooled to remove the heat contained in the walls, ceiling, floor, and doors before loading with already cooled products. If not removed, this heat can be rapidly conducted to the cargo. Moreover, the trailer should arrive at dock or near the desired carrying temperature to prevent food loaded near trailer walls from warming under hot ambient conditions or cooling too much under cold ambient conditions. During hot weather, precooling reduces the chance of overloading the refrigeration system. It also prevents further warming or thawing of the product from heat in the walls and floor.

A number of variables, such as ambient temperatures, refrigeration unit capacities, and insulation, make it difficult to have a set procedure for precooling. A recommended procedure is to set the thermostat at the desired temperature, close the doors of the vehicle, and run the refrigeration unit until the heat transfer through the vehicle body is stabilized at the thermostat set-point. This may take 2 or more hours in hot summer weather. Refrigeration units equipped with microprocessors have an automatic precooling cycle function. Still, schedule adequate time for precooling.

In temperate climates with low humidity, the trailer should be cooled to the desired set-point temperature, as determined by product, customer, and/or shipper requirements. **DOUBLE CHECK the setting to ensure it was set properly!** If loading from an open dock in a humid environment, the trailer should be as cool as possible, but not so cold that water condenses on inside surfaces. This is called the dew point temperature of the outside air. Temperatures below the dew point cause water to condense on walls, which may damage fiberboard packages and/or contaminate food.

**CAUTION:** Shut the refrigeration unit off when loading from an open dock. Leaving the doors open may result in ice forming on the refrigeration coil, blocking refrigerated air circulation during transport.

During extreme subfreezing weather, prewarm the interior of the vehicle before loading commodities such as fresh onions or potatoes. Most vehicles are equipped with a heating cycle on the refrigeration unit. Operate the unit

on the heat cycle far enough in advance of loading to stabilize the interior air and body temperature of the trailer at the desired transit temperature of the product.

After the equipment has been adequately precooled, the refrigeration system should be turned off and then the trailer doors can be opened for loading the cargo. This prevents moisture from condensing or ice from forming on the evaporator coil if loading from an open dock; vehicle refrigeration is not needed in an enclosed, refrigerated dock. Conversely, running the reefer unit when vehicle doors are open causes hot, ambient, humid air to condense on cargo, ice and hoarfrost accumulation on the cargo and interior of the trailer, and causes wet cartons, cargo thawing and temperature abuse.

Hoarfrost is a white frost that occurs when water vapor touches a cold surface such as frozen cargo (e.g., cartons and IQF shrimp and its packaging) and other surfaces in cold rooms or transit vehicles containing frozen products. Hoarfrost can develop when the humidity and moisture in the air enters cold rooms/transit vehicles with doors open and then freezes instantly on the frozen items.

A conventional thermometer can be used to measure wall temperature by placing the temperature probe against an inside wall and covering it with a dry cloth. An infrared thermometer can also be used to check the inside wall temperature if the emissivity adjustment is set to the correct emissivity of the interior surface material. Infrared thermometers without emissivity adjustment are often factory set for an emissivity of biological materials, so may work for measuring the temperature of wood, but probably will not provide accurate temperatures of painted or metal surfaces.

A useful trailer precooling guide is as follows (J. Thompson - UC Bulletin):

Precool trailers, especially during warm weather:

- a. Trailers to be loaded at refrigerated docks should be precooled to their desired thermostat set point.
- b. Trailers to be rapidly loaded (15 to 20 minutes) at non-refrigerated docks should be cooled to about 5°F above the shipper's specified thermostat set point.
- c. Trailers that will be loaded slowly (30 minutes or more) at non-refrigerated docks should be precooled to about 5°F lower than a temperature half way between the ambient air temperature and the desired thermostat set point.

For example, if the ambient air temperature is 75°F and the desired set point is 35°F, the trailer should be precooled to 50°F.

$75^{\circ}\text{F} - 35^{\circ}\text{F} = 40^{\circ}\text{F}$  (the difference between the ambient and setpoint temperatures)

and  $75^{\circ}\text{F} - 20^{\circ}\text{F} = 55^{\circ}\text{F}$  (halfway between the ambient and setpoint temperatures)

and  $55^{\circ}\text{F} - 5^{\circ}\text{F} = 50^{\circ}\text{F}$  (5°F below the halfway point)

This will prevent accumulation of excess moisture or hoarfrost on the trailer's inner surfaces, cargo damage, contamination, and subsequent extensive cycling and defrosting of the refrigeration unit.

## **PRECOOLING THE PRODUCT**

To maintain a fresh appearance, prevent decay, and extend the market life of most fresh fruits and vegetables, it is necessary to start lowering the temperature and removing the field heat from the product as soon after harvest as possible. Any cooling completed before the product is shipped is referred to by the industry as 'precooling.' Precooling may include one or a combination of the following methods:

- refrigerated forced air;
- vacuum cooling;
- hydrocooling; and
- slush ice or package ice.

Some fresh fruits, vegetables, and carcass meats are shipped before they have been precooled to the proper transit temperature. The ideal situation would be for the carrier to accept only properly precooled product. When this is not practical, the trailer's refrigeration system must bear the additional heat load.

Truck refrigeration units may have enough reserve capacity to remove a reasonable amount of heat in addition to respiration heat and heat transferring through the vehicle body. However, if the product is much above the desired transit temperature at loading time, the entire heat load should be estimated (see Appendix I). If the estimated heat load is more than the refrigeration unit is rated to bear, the trailer should not be used.

With regard to freeze cargoes, refrigeration equipment used to transport frozen foods is designed to remove heat that may transfer into the load compartment (railcar, truck, or container). However, the refrigeration capacity of transit vehicles does not provide for removal of much heat from the load.

Therefore, if products are loaded with the temperature warmer than 0°F (-18°C), there is little or no opportunity for the product temperature to be reduced to the desired level during transit. Similarly, retail display equipment cannot be expected to remove significant heat from frozen foods. Therefore, it is imperative that frozen foods be at 0°F (-18°C), or colder, when they are loaded for transport.

Considerations to remember concerning precooling products and equipment include the following:

- The perishable product must be precooled to the shipper's specified temperature prior to loading. **Transit vehicles are not designed to effectively precool chill or frozen cargoes!**
- If the interior of the transit vehicle is hot, the cargo can potentially be temperature abused by contact with hot sidewalls and floors of the containers.
- Precooling the transit vehicle (with the doors closed) can help suppress temperature-induced damage to the perishable cargoes from hot floors and sidewalls.
- Loading transit vehicles in a hot humid and open environment is a bad practice. Refrigerated loading docks with cold tunnels are recommended. Cold tunnels prevent outside ambient air from entering the refrigerated dock and the interior of precooled transit vehicles.
- In open conditions with hot humid air,
  - condensation can form on the exposed cartons ('cargo sweat') when the supplier moves the refrigerated cargo from the cold room to a hot, humid dock or open space. Under hot, humid conditions, the problem of cargo sweat will likely persist even if the transit vehicle is not precooled.
  - condensation can occur near the doors of the precooled transit vehicle and on the ceiling. The concern is that moisture on the ceiling might fall on the cartons.

## TEMPERATURE RECORDING AND TRACKING

Recording and tracking product temperatures is not only one of the most important tasks to assure the quality and safety of horticultural products, it is also a key requirement of the Food Safety Modernization Act. There are two ways to accomplish this: using telematics or temperature recorders (Figure 34). Telematics and, more precisely, remote temperature monitoring and/or control, as described under, "Telematics" in section I, uses a vehicle-

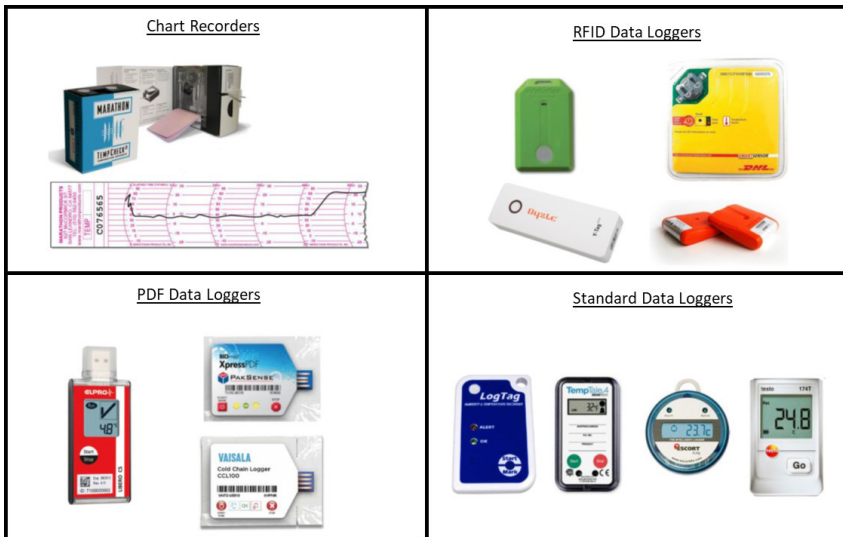

**Figure 34.** Illustration showing several types of temperature data loggers. (Source: Adapted from ELPRO-BUCHS AG *The good, the bad, and the ugly. Needs and applications of data loggers for the cold chain*. 5th Int'l Cold Chain Workshop. University of Bohn, 2013)

mounted device to capture the data from the refrigeration unit’s controller and/or independent sensors located either in the cargo space or inside product cartons, and transmit these data utilizing a cellular or satellite communications network. Using this method, the temperature of the product and/or the cargo space can be monitored continuously in near real-time.

Temperature recorders are also utilized for capturing cargo space or product temperature data and are widely accepted by growers, shippers, transportation providers, and retailers. The usefulness and effectiveness of temperature recorders may vary based on the sensor’s operating range, accuracy, resolution, as well as their location. Temperature recorders may require the user to program and/or activate the device prior to placing the recorder in the desired location. The user may also need to download the data stored in the temperature recorder once retrieved from the vehicle transporting the product. The use of a Time-Temperature Indicator (TTI) on each consumer package may be appropriate in the distribution system for reduced-oxygen-packaged products in which refrigeration is the sole barrier to outgrowth of non-proteolytic *C. botulinum* (the causal agent of botulism poisoning), and in which the spores have not been destroyed.

Portable temperature recorders (also known as temperature monitors) are routinely used to establish if a shipment of perishable foods was maintained at the desired carrying temperature for insurance purposes.

Temperature sensors inside the refrigerated cargo space may capture the temperature of the product, the temperature of the air surrounding the product, the cargo’s return air temperature, or the cargo’s supply air temperature. Temperature sensors may also be placed inside or outside the product’s packaging.

The shipper should input or mark the date and local time on the label or data file and document the specific location of each recorder in the load with a bright identifying label on the outside of the carton, and on a preloading form that is attached to cartons nearest the entry doors of the refrigerated equipment (Figure 35).

Air temperature recorders should not be placed directly on truck, trailer, container, or railcar walls, as this may result in elevated readings that do not accurately reflect the air temperature in the load space due to heat transferred across the walls of reefer equipment.

The shipper should install the recorders inside cartons in three locations in the container, trailer or railcar as follows (Figure 36):

- Inside the first pallet near the front bulkhead of the reefer unit to detect short cycling of refrigerated air
- Inside a pallet near the center of the load where product heating may occur



**Figure 35.** Illustration showing sample labeling and marking of boxes with data loggers inside. (Source: J. Saenz – Adapted from published online photos.)

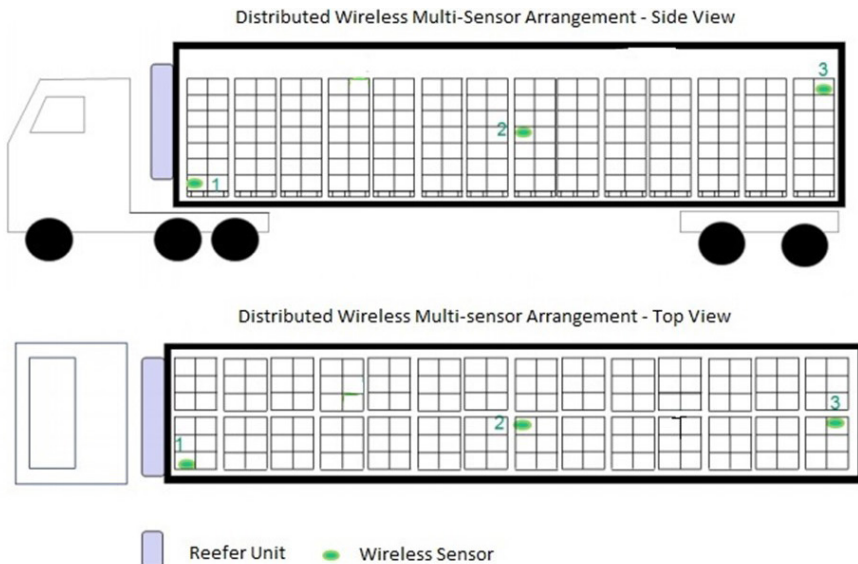

**Figure 36.** Illustration showing placement of temperature recorders in a reefer trailer. (Source: Adapted from Ruiz-Garcia, L. et al. 2010. *Sensors*, Volume 10, Issue 5, Pages 4968-4982. Article *Testing ZigBee Nodes for Monitoring Refrigerated Vegetable Transportation under Real Conditions*. Published by MDPI AG, Basel, Switzerland)

- Inside the last pallet at eye level to record air temperature at the farthest point from the reefer unit.

### OTHER TYPES OF RECORDERS

Although temperature is the most critical parameter being monitored in shipments of horticultural products, data from other parameters could significantly increase our understanding of horticultural products’ conditions and those of the environments surrounding these products.

There are other types of recorders used to monitor these parameters, such as relative humidity, oxygen (O<sub>2</sub>), carbon dioxide (CO<sub>2</sub>), and ethylene to name a few. The O<sub>2</sub> and CO<sub>2</sub> are particularly important in shipments using controlled or modified atmospheres.

## III. Loading and Unloading Considerations

The packaging, handling, and trailer equipment for perishable foods varies considerably, and this complicates loading decisions for truck drivers.

Consider the following factors, along with the kind of equipment available, when planning a load.

## **TYPE OF AIR DELIVERY SYSTEM**

Currently there are two types of air delivery systems available on refrigerated trailers and containers. Each system requires specific loading procedures for both hand-stacked and palletized loads to maximize cooling efficiency and maintain temperature control.

### **TOP-AIR DELIVERY**

Top-air delivery is the conventional system used in refrigerated trailers (see Figure 17). With this system, high-velocity, but-low pressure, air exits the refrigeration unit at the front ceiling, travels over the top of the load, down between the end of the load and rear doors, and under and through the load to return to the refrigeration unit at the front of the vehicle. When loading a top-air vehicle with hand-stacked packages, keep pathways open for airflow back to the refrigeration unit (Figure 37). For palletized loads, center loading (Figure 38a) to keep an air space between the product and the vehicle walls, or airflow loading, which adds an air space between the two rows of pallets (Figure 38b), are recommended. Do not allow the cargo to touch the air delivery chute or block the flow of air from the reefer system. Doing so will interfere with proper air distribution within the trailer, which can result in cargo warming. Pinwheel loading (Figure 38c) is not recommended due to short cycling of conditioned air and inferior temperature management.

### **BOTTOM-AIR DELIVERY**

Bottom-air delivery systems are used mainly on intermodal van containers for export shipments. In bottom-air systems, refrigerated air is forced down the front bulkhead and under the load through a T-rail floor, and then vertically up through the load (see Figure 18). A high static pressure is maintained under the load to assure a low-velocity but steady movement of air through small openings in the load. Load a bottom-air vehicle tightly over the floor area, and cover any open space on the floor not covered by the load to maintain the air pressure under the load whether the load is hand-stacked or palletized (Figure 38d).

## **TYPE OF PACKAGING**

Load packages (i.e., boxes, cartons, lugs, and crates) in a manner that takes maximum advantage of their inherent strength. Different packages are stacked and handled in varying ways because of their design, the way they



**(A) LONGITUDINAL VIEW**

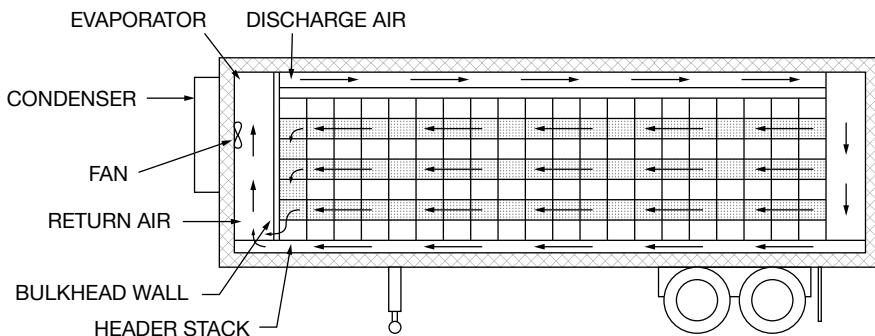

**(B) HEADER STACK**

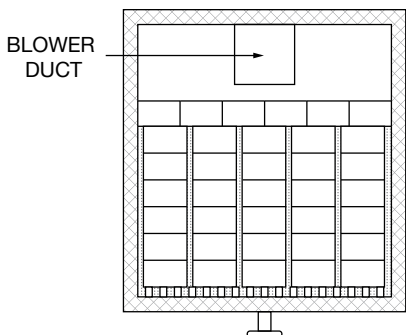

**(C) REAR VIEW**

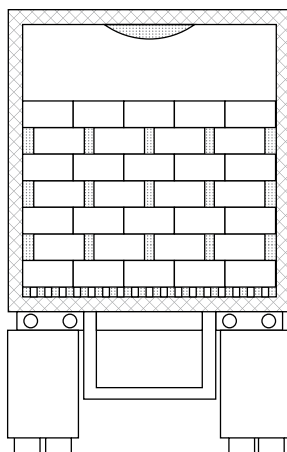

**Figure 37.** Typical airflow loading patterns in a top-air delivery vehicle for commodities that are hand stacked: (a) longitudinal view, (b) header stack, and (c) rear view of all other stacks.

are packed, and the material from which they are made. Most packages are designed to withstand more pressure or weight on one side or area without collapse or damage to the contents. Certain types of ‘packs’ tend to leave a bulge on one or more faces of the package. If at all possible, do not load bulged packages with pressure on the bulging faces. Wooden wirebound crates used for corn are an example of this type pack. Load these packages on their sides to prevent crushing of the contents under the bulge.

Wooden boxes, lugs, and wirebound crates are designed to bear weight on the ends only. The tops, bottoms, and sides usually are made up of thin slats which serve only to keep the product within the package. Stack these

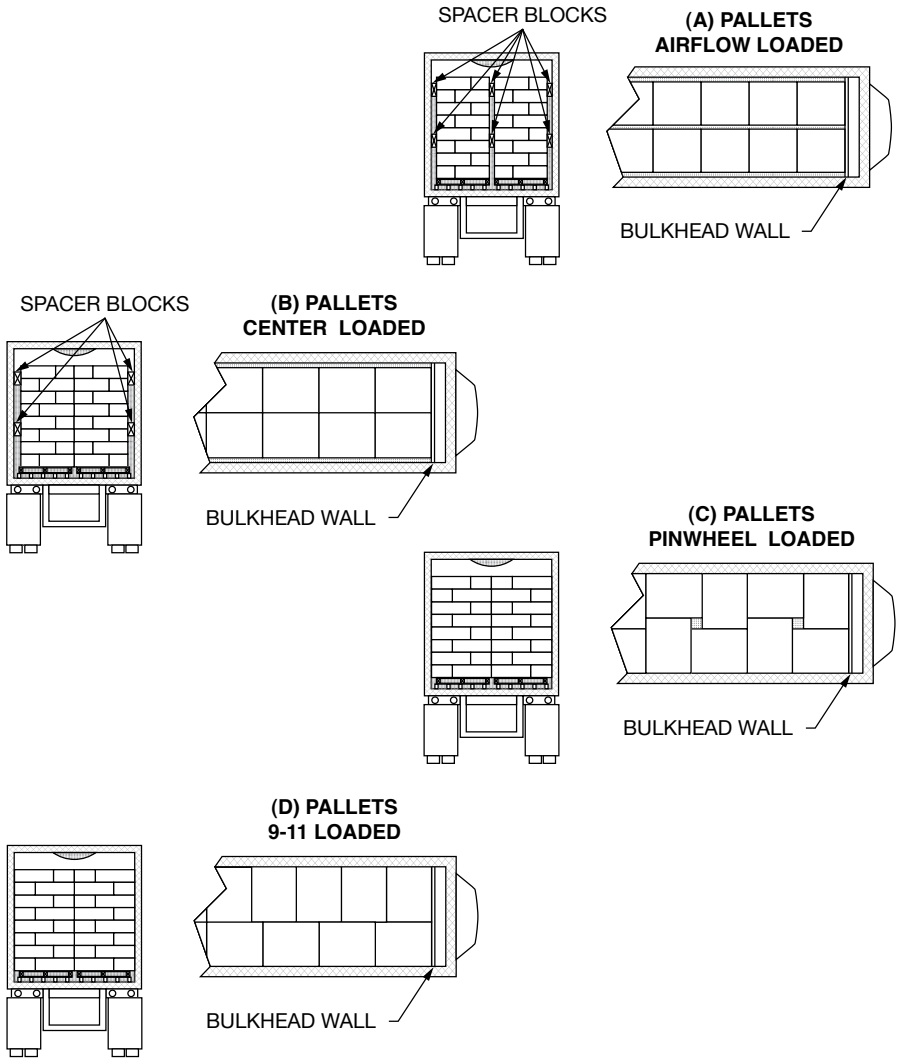

**Figure 38.** End and overhead views of basic pallet or unit load patterns in a trailer or container: (a) center, (b) airflow, (c) pinwheel, and (d) 9-11. (Note: Pinwheel loading is not recommended, but if used, the pallets must be four-way type, or air flow under the load will be blocked.)

packages directly on each other so that the overhead weight is borne by the ends of the crate, or the contents may be severely crushed and bruised.

Corrugated fiberboard boxes are designed to bear vertical overhead weight on their four walls. Load fiberboard boxes upright on their bottoms and stack evenly on top of each other. The four corners are the strongest points. Avoid

cross-stacking where excessive pressure put on the boxes at midsection may cause product damage. Boxes may usually be cross-stacked on the top layer.

Wooden baskets and hampers are designed to withstand overhead weight bearing vertically on their tops or bottoms. Fasten the cover lids securely at all fastening points so that the lid bows slightly. The bow distributes overhead weight evenly to the sides of the basket rather than letting it bear directly on the produce under the cover.

Bulk and bagged commodities are highly susceptible to bruising from overhead weight, especially when loaded on grooved or rough floors. Commercial cushioning materials, such as paper and plastic foam pads, will provide some protection for these products. Fiberboard slip sheets also may be used for floor cushioning. Any cushioning material should be perforated for air circulation. Do not use materials, such as straw, that will block air circulation under the load.

During cold weather, floor cushioning material also serves as insulation to prevent freezing damage at the point it is most likely to occur. However, the most effective method of preventing freezing of the product at floor level is to circulate warmed air under the load. In vehicles not equipped with high airflow floors, raise the load on pallets or floor racks to get adequate air circulation under the load.

## **WHETHER FROZEN OR NON-FROZEN**

Load frozen foods that have been cooled to the desired 0°F (-18°C) or below transit temperature in a different manner from fresh respiring produce. Load boxes of frozen food tightly together with as little contact with the vehicle floor and walls as possible. The goal is to have cold air circulating around the load perimeter to intercept heat radiating through the body of the trailer before it reaches the frozen cargo. (See also “Frozen Foods” in section V, “Individual Commodity Requirements”)

- Airflow principles – cold air envelope (frozen cargo), airflow around and through the load (non-frozen)

## **BRACING NEEDS**

Bracing prevents the load from shifting and blocking air circulation channels and/or causing physical damage to the product. It is especially important to secure packages in the top layers toward the rear of the load. Here they

are highly susceptible to bouncing and toppling, and subsequent bruise and abrasion damage from shock and vibration transmitted from the road.

Prevent the accumulation of lengthwise slack space during loading. Use cross-bracing at the end of the last stack to prevent the cargo from shifting backward and blocking air circulation at the rear doors. This is particularly important in loads for piggyback or TOFC (trailer-on-flatcar) rail shipments, where the vehicles may be loaded so they are moving backwards. If the load is a split shipment or a multiple drop-off (one that is consigned to several receivers), use cross-bracing at the end of the last stack left after each drop-off to keep the cargo in place until the next stop is reached. Use air bags, spacer blocks, and load lock bars to secure palletized loads.

## COMPATIBILITY OF MIXED LOADS

Many truck shipments as well as commercial and military container shipments to Alaska, Hawaii, the Caribbean, Guam, and/or the outer islands may contain two or more different food products. Consider six important factors in determining the compatibility of produce in mixed loads:

1. Required commodity temperature
2. Required relative humidity
3. Emission of physiologically active gases such as ethylene
4. Chemicals such as sulfur dioxide (SO<sub>2</sub>), chlorine dioxide (ClO<sub>2</sub>), and ozone (O<sub>3</sub>)
5. Odor-producing and odor-absorbing characteristics
6. Modified and controlled atmosphere requirements

The desired transit temperature of products shipped together should be within reasonably close range. For example, mature green tomatoes require a transit temperature of 55°F (13°C) to avoid chilling injury (see, “Chilling and Freezing Injury,” under “Cargo Space Management,” for further information) and should not be shipped in combination with lettuce needing a transit temperature of 32°F (0°C). However, compromise temperatures may be used for short duration transports of a day or less.

The relative humidity (RH) requirements of mixed products should be reasonably close. Dry onions and hard squash require low RH (50 to 70%) while all other fresh fruits and vegetables require from 85 to 100% RH. Some products may be shipped in contact with ice and are saturated by meltwater. Other products may be injured by contact with ice or water saturation. See “Ice,” under “Refrigeration Methods,” in section I, “Important Factors in Protection of Perishable Foods,” for further information.

Certain fruits and vegetables produce ethylene gas during respiration. Ethylene may bring about premature ripening or aging (i.e., yellowing) of many fresh fruits and vegetables. Ethylene causes other, unique types of damage to carrots, lettuce, most flowers, and some nursery stock. Fruits and vegetables that produce significant quantities of ethylene include apples, apricots, avocados, bananas, cantaloupes, cherimoyas, feijoas, figs, honeydew melons, kiwi fruit, mangoes, papayas, passion fruit, peaches and nectarines, pears, plums, sapotes, and tomatoes. Commodities that should retain a green color during transit, such as bananas, cucumbers, leafy greens, and bell peppers, should not be shipped in combination with heavy ethylene producers. Ethylene production is less pronounced at temperatures near freezing than at higher temperatures. Exchanging the air in the vehicle periodically by opening vent doors will help reduce ethylene buildup. Ethylene scrubbers also are available commercially and may be beneficial for long duration transports of several days or more.

Fumigation with sulfur dioxide ( $\text{SO}_2$ ) gas is widely practiced to control mold on grapes during transit and in storage. However, other fresh fruits and vegetables can be tainted or injured (bleached) by  $\text{SO}_2$  and can absorb the  $\text{SO}_2$  odor. Grapes that have been treated with  $\text{SO}_2$ , or are being transported with  $\text{SO}_2$  releasing pads, should not be mixed with any other fruits and vegetables. Sulfur dioxide is considered by the U.S. Food and Drug Administration (FDA) as generally recognized as safe (GRAS) when used in accordance with good manufacturing practice, **except** that it is not to be used in meats; in food recognized as a source of vitamin B1; on fruits or vegetables intended to be served raw to consumers or sold raw to consumers, or to be presented to consumers as fresh (21 CFR 182.3862). The US has set a tolerance for sulfite ( $\text{SO}_3^{2-}$ ) residues of  $\text{SO}_2$  in or on grapes of 10 ppm (40 CFR 180.444). Moreover,  $\text{SO}_2$  concentration in transport vehicles must be below 2 ppm before moving over public roads or highways.

Chlorine dioxide gas and  $\text{O}_3$  gas are sometimes used as sanitizers in transport vehicles and can also cause bleaching of various fruits and vegetables.

Take care not to mix shipments of odor-producing products with odor absorbers. Odors given off by apples, citrus, onions, pineapples, and fish are readily absorbed by dairy products, eggs, meats, and nuts. Some products, such as apples, are capable of both giving off and receiving odors. Incompatible fresh fruit and vegetable loading combinations include:

- Odors from apples or pears are absorbed by cabbage, carrots, celery, figs, onions, and potatoes;
- Celery also absorbs odors from onions and carrots;

- Odor from leeks is absorbed by figs and grapes;
- Odor from green onions is absorbed by figs, grapes, mushrooms, rhubarb and corn;
- Odor from dry onions is absorbed by apples, pears, celery, and citrus;
- Odor from peppers is absorbed by avocados, green beans, and pineapples;
- Eggplants absorb odor from ginger;
- Pineapples absorb odor from avocados;
- Citrus fruits may absorb odors from any strongly scented vegetable.
- Apples and pears may acquire an earthy taste and odor if shipped with potatoes.

As a general rule, modified and controlled atmosphere (MA and CA) and temperature set points for mixed produce loads are generally compromises. However, deviating too much from any product's intended MA and CA settings by raising the temperature, reducing the O<sub>2</sub>, or increasing the CO<sub>2</sub> may lead to initiation of fermentative metabolism that can damage or kill the produce. Never use modified and controlled atmosphere settings meant for products in vented cartons when the products are already in modified atmosphere packaging or risk development of a damaging atmosphere within the packages.

When shippers mix non-compatible produce, they should do so based on experience and knowledge of all of the risks. Notwithstanding, some produce items may tolerate less than perfect conditions for short transits.

Refer to “Load Compatibility Groups” in Appendix II for determining the loading compatibility of various products.

## **WHETHER PALLETIZED OR UNITIZED**

Depending on the commodity and area of production, anywhere from 75% to 90% of domestic fresh fruit and vegetable shipments are unitized on pallets. Unitized shipments offer the advantages of reduced labor and less manual handling (therefore less mechanical damage) of the product, but have unique loading requirements for protecting food products during transit. Most palletized perishable food products should be center- or airflow-loaded in top-air delivery trailers (Figure 38a-b) and 9-11 loaded in bottom-air delivery containers (Figure 38d). See also section IV, “Loading (Stowage) Patterns” and “Packaging and Unitization” in section I, “Important Factors in Protection of Perishable Foods.”

## LENGTH OF TRANSIT PERIOD

The length of time a product will be in transit will affect loading decisions. For example, a denser loading pattern can be used in an overnight shipment compared to one that takes several days in summer heat. In overseas shipments where transit periods may be 2 weeks or longer, it is imperative that all of the recommended transit requirements for the individual commodity be met to assure maximum shelf life.

## LOADING AND UNLOADING CHECKLISTS

For all types of refrigerated vehicles, the following is a brief checklist of critical tasks that should be completed at the time of loading and prior to transit:

- Complete loading checklist and stowage diagram.
- Load cargo below the red height-load limit line.
- Stabilize load to prevent shifting in transit.
- Locate portable temperature recorders at specified locations in the transit vehicle.
- Assure that thermostat is set to correct temperature (degrees C or F).
- Assure that fresh air exchange rate is set correctly.
- Assure that generator is operating and has adequate fuel.
- Assure that vehicle meets highway weight standards.
- Assure that security seal is properly attached to rear door.
- Assure that security seal number is recorded.
- Precool vehicle to desired thermostat setting.
- Shut off the refrigeration unit when loading.
- Record product surface or pulp temperatures during loading.
- For hand-stacked loads, use an airflow loading pattern with a header stack and lengthwise air channels (truck trailer top-air only; Figure 37).
- For transporting chill and freeze cargoes in top-air delivery and freeze cargoes in bottom-air delivery vehicles, avoid loading tight against flat walls; for top-air delivery reefer trailer shipments, use an offset-by-layers pattern for hand-stacked loads (Figure 31) or center-load unit loads (Figures 37 and 38).
- Allow at least 4 inches (10 cm) of space between end of load and rear doors for return air.
- Use pallets on floor if floor channels or ducts are less than 2 1/4 inches (6 cm) deep.

- Secure hand-stacked loads at rear with wood gates, load bars, or other cargo restraining devices.
- Secure unitized loads with one or more of the following: air bags, bracing, shrink film or netting, or strapping.

The following are more detailed checklists for loading and unloading reefer trailers.

### **Before Loading:**

- Refrigeration unit and trailer are pre-tripped.
- Refrigerated trailer is precooled to shipper specified carrying temperature (for reference, see “Precooling the Product and Equipment” in section II, “Preparation for Loading”).
- The refrigeration unit is operational.
- Thermostat is set at shipper’s specified temperature.
- The refrigeration operating mode is set at shipper’ specified setting, such as continuous or start top/cycle sentry.
- Inside length, height, and width is adequate for the load.
- Trailer interior is clean and dry.
- Trailer is odor free.
- Floor drain holes are free of obstruction.
- Any damage to the interior walls has been repaired.
- Door seals are in good condition and seal tightly when closed.
- Air chute is in good repair and properly attached to ceiling.
- Door seals are in good repair and floor drains are open.
- Front pressurized bulkhead is structurally sound and firmly attached.
- Cargo is stowed on clean four-way pallets.
- Pallet loads are properly unitized and well secured on pallet.
- Cargo is at the shipper-specified carrying temperature (manually measure).
- Products to be mixed-loaded are compatible in their needs for temperature, humidity, ethylene sensitivity, and odors.

### **During Loading:**

- Boxes do not touch air chute with cargo or block delivery air from refrigeration unit.
- Cargo is center-stowed and braced away from walls and rear doors.
- Cargo is turned, pinwheeled or straight-in stowed.



- Unrefrigerated cargo is separated from refrigerated product by a space to avoid warming the cooled product.
- Packaged iced product and/or top ice are not placed on top of other products.
- Airflow is not blocked by ice, dunnage, slip sheets or plastic wraps.
- Cargo is loaded on pallets and not directly on the floor.
- Portable temperature recorders are marked with load identification, start time, and date.
- Portable temperature recorders are started and marked with their location in the load.
- Portable temperature recorders are placed at correct locations in the load.
- Thermostat is set to correct temperature, check for Celsius or Fahrenheit specification.
- Vehicle meets highway weight regulations.
- The position of recorders, air bags and other details are recorded on stowage diagram.

#### **During Unloading (Devanning):**

- Thermostat is properly set at shipper's specified temperature.
- The refrigeration operating mode is properly set at shipper's specified setting of continuous or start top/cycle sentry.
- Trailer interior is clean, dry and free of odor.
- Floor drain holes are free of obstruction.
- Floor drains are open and free of debris.
- Air chute is in good repair and properly attached to ceiling.
- Cargo does not touch air chute or block delivery air from refrigeration unit.
- Airflow is not blocked by ice, dunnage, slip sheets or plastic wraps.
- Door seals are in good condition and seal tightly when closed.
- Front pressurized bulkhead is firmly attached.
- Cargo is stowed on clean four-way pallets.
- Pallet loads well secured unitized on pallets.
- Cargo is at the shipper-specified carrying temperature (measure manually).
- Products in load are compatible in their needs for temperature, humidity, ethylene sensitivity, and odors.

- Cargo is properly stowed – for instance, load is braced away from walls and center lined stowed, turned, pinwheeled or straight-in.
- Unrefrigerated cargo is separated from refrigerated product by a space to avoid warming the cooled product.
- Packaged iced product and/or top ice are not placed on top of other products.
- Cargo is loaded on pallets and not directly on the floor.
- The location of temperature recorders, air bags and other detail are recorded.
- Recorder data is retrieved.
- Thermostat is set using the correct temperature scale (i.e., check for Celsius or Fahrenheit specification).
- Vehicle meets highway weight regulations.
- Stowage diagram is completed.

For reference, container loading and devanning checklists are shown in Appendix V.

---

## IV. Loading (Stowage) Patterns

Unitized loads, primarily pallets, have virtually replaced hand-stacked loads in refrigerated trailers and are extensively used in marine containers. Loading is much faster with unitized products; unitization also saves on labor costs and improves reliability. Hand-stacked loads are seen primarily in railcar shipments and inbound (i.e., imported) marine container loads.

### LOADING TRAILERS AND RAILCARS WITH TOP-AIR DELIVERY

#### UNITIZED OR PALLET LOADS

In top-air delivery trailers, unitized or pallet loads are usually loaded in one of three basic patterns (Figure 38a-c). The dimensions of the pallet base and the interior dimensions of the vehicle have considerable influence on the pattern used. The amount of bulge, overhang, whether top iced, and ventilation requirements are other determining factors for unit load patterns. **Slip sheets are not recommended for unitizing fresh fruits and vegetables in trailers or railcars** because airflow is restricted below the load, allowing direct heat transfer through the floor to the product on the bottom layer. Upward airflow through the load is also blocked.

To maximize cooling of palletized loads in trailers with top-air delivery:

- Secure packages to each pallet with appropriate cornerboards, strapping, tape, and/or netting. Plastic film wrapping is not recommended for fresh fruits and vegetables because it restricts airflow during transport.
- Center or airflow-load the pallets, off the walls (Figures 37a and b).
- Load the pallets with their stringers (base supporting rails) running the length of the trailer to facilitate airflow.
- Secure the load with spacers and bracing to prevent the pallets from shifting and blocking air spaces between the walls and rows of pallets.
- Pallets should not be stacked so high that the air chutes are compressed and air circulation is blocked.
- Allow at least 4 inches (10 cm) of open space between the end of the load and the rear doors for air return.

Hand-stacked loads are not recommended in top-air delivery truck trailer systems for respiring food products. However, when used, the packages should be stacked in an airflow pattern with lengthwise air channels through and around the load for maximum heat removal and to intercept heat penetrating the trailer body (Figure 37). Floor channels are typically too shallow (less than 2 inches; 5 cm deep) to provide adequate space for air return under the load (Figure 32). The product should only be loaded on floor racks or pallets with their stringers running lengthwise through the load. A few fresh produce items in sacks or bags, namely carrots, onions, and potatoes, are hand-stacked when shipped in railcars; loose potatoes are also sometimes shipped in railcars. Neither of these practices is recommended due to the inherently poor airflow and temperature management associated with them. More mechanical damage can also be expected with hand-stacked and bulk loads.

## LOADING CONTAINERS WITH BOTTOM-AIR DELIVERY

Bottom-air delivery containers are typically designed with deep floor channels (greater than 2 inches [5 cm]) that allow adequate airflow for unitized loads and hand-stacked loads.

### UNITIZED OR PALLET LOADS

For *unitized freeze or non-respiring loads* on pallets or slip sheets in vehicles with bottom-air delivery reefer containers, observe the following. **Slip sheets are not recommend for unitizing fresh fruits and vegetables in reefer containers** because upward airflow through the load is also blocked.

The use of pallets is highly recommended. Pallets, when loaded so air can flow freely through the pallets to return to the evaporator, help protect the product from heat passing through the floor of the truck. When using pallets, it is important to refrain from stacking extra boxes on the floor at the rear of the truck, because this will cut off the airflow.

- Load the unit loads together as tightly as possible.
- Cover any floor space not covered with the unit loads with fiberboard or other appropriate material to force the air up through the unit loads.
- Ensure that there are holes or slots in plywood pallet floors allow refrigerated air into the unit load.
- For non-frozen loads, block the ends of the pallets at the rear of the load to assure that air pressure is maintained under the load.

Palletized chill and frozen foods carried in reefer containers with bottom-air delivery systems should be loaded in a '9-11' configuration (Figure 38d), with 9 pallets oriented with the longer side of the base lengthwise, and 11 pallets with the shorter side lengthwise. This maximizes the number of pallets that can be loaded into a 40-foot container while allowing the load to be center-loaded. If the vehicle is smooth-sided (i.e., not equipped with fluted, corrugated or inverted ribbed walls), frozen and non-respiring chill loads should be center-loaded to reduce the contact of the pallets and cargo with the walls of the vehicle. Figure 39 shows the effect of unit and pallet load patterns on the amount of product exposed to contact with wall surfaces. Reducing the amount of surface contact will improve product arrival temperatures and reduce the chance of product freezing or warming in extreme weather conditions.

Unitized loads should be stacked squarely on the pallets and stabilized to prevent toppling during shipping. See "Packaging and Unitization" in section I, "Important Factors in Protection of Perishable Foods," for more details.

**CAUTION:** Film wraps are not recommended on fresh fruits and vegetables as the film may block ventilation and allow heat buildup.

Brace unit loads to prevent them from shifting against the rear doors and blocking airflow around the end of the load. Figure 40 illustrates an easily constructed wooden brace. Load lock bars also help prevent shifting.

Do not mix partly unitized and partly hand-stacked loads. In this case, put the hand-stacked portion on pallets to make it consistent with the rest of the load and allow better air circulation.

**PRODUCT ON SLIPSHEETS**

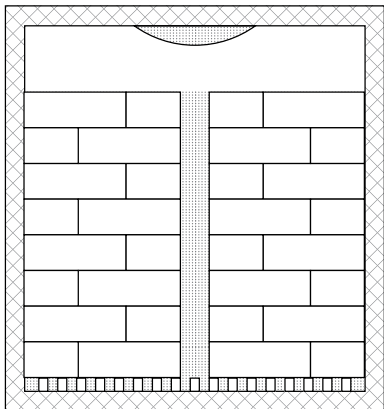

(A) WALL LOADED = 20%

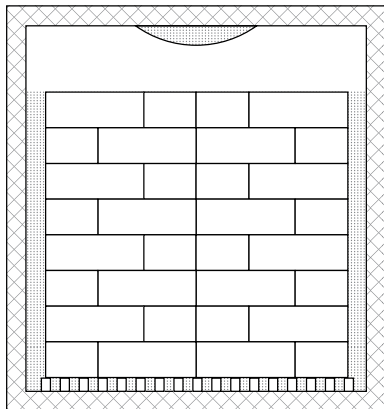

(B) CENTER LOADED = 5%

**PRODUCT ON PALLETS**

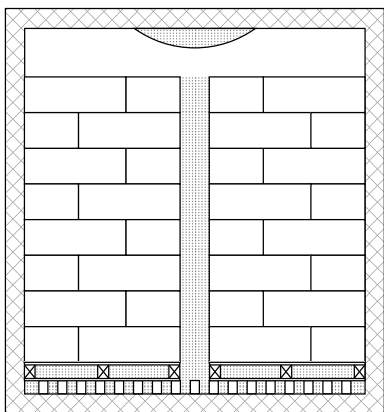

(C) WALL LOADED = 15%

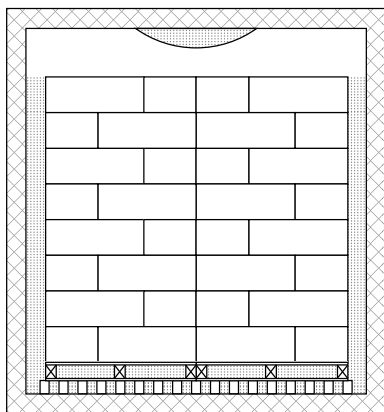

(D) CENTER LOADED = 0%

**Figure 39.** Effect of different unit load patterns on the percentage of cartons contacting the floor and walls in a typical load of a perishable product.

**HAND-STACKED LOADS**

Figure 41 is a dimensional view of a load in a trailer or container showing arrangement of the packages in rows, stacks, and layers. A row is a line of packages extending the length of the trailer, one package in width, and as high as the load itself. A layer is a course or stratum of packages, one package high, usually extending the length and width of the load. A stack is a line of packages extending across the width of the container and from the top to the bottom of the load, parallel to the front and rear end of the vehicle, and one package in length.

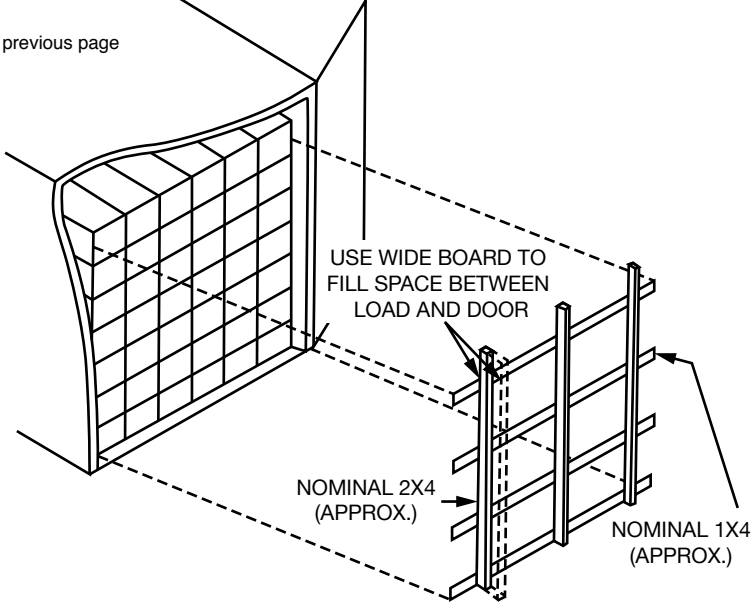

**Figure 40.** Example of a method for bracing a load at the rear doors.

---

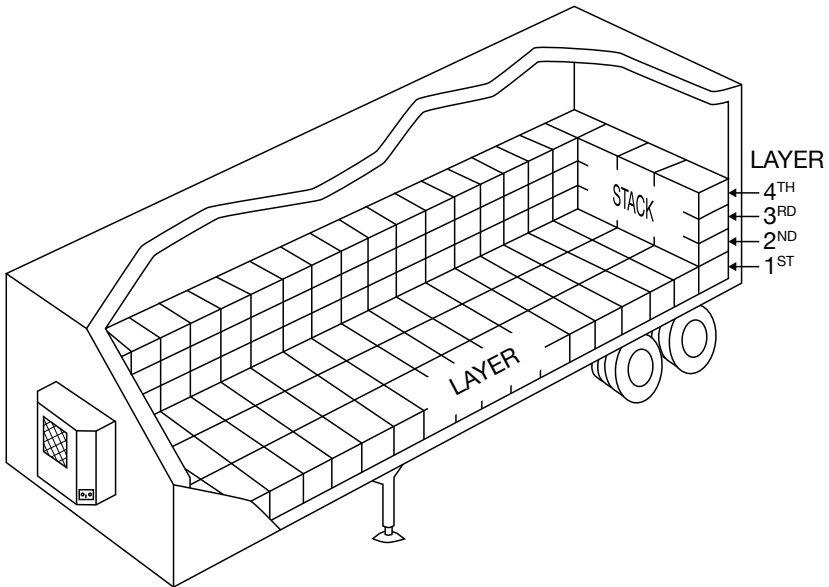

**Figure 41.** Dimensional view of a hand-stacked load showing arrangements of packages in rows, stacks, and layers.

---

Packages should be loaded in bottom-air delivery vehicles so as to evenly distribute air pressure under the entire load. Fresh fruits and vegetables should be packed in packages with aligned top and bottom vent holes to facilitate maintenance of product temperature.

For *hand-stacked* loads in vehicles with bottom-air delivery the following apply:

- Block-stow chilled cargo packages tightly together from front to rear and sidewall to sidewall of the vehicle. For freeze cargoes originating in hot humid environments, block stow the cargo and position spacers between the side walls of the containers and the cargo.
- Stack packages of chill cargo with top and bottom vent holes directly on top of each other with the vent holes aligned.
- Leave at least 4 inches (10 cm) at the front, rear, and between the top of the load and the ceiling for air to return to the refrigeration unit.
- For chilled cargoes, block any floor space in the container not covered by the packages, including T-rails at the rear of the vehicle. This seals the floor so that air will be forced upward through the load and not short-circuit around the sides, front, or end of the load at the doors (Figure 18).

## VENTED LOADS

In some cases, ambient air is vented through **non-refrigerated** top-air delivery trailers to cool loads of fresh produce. Fresh air is vented into the trailer or container to prevent oxygen starvation or to displace metabolic gases such as ethylene or CO<sub>2</sub>. For proper ventilation refer to “Loading Trailers and Rail Cars with Top-Air Delivery” in section IV, “Loading (Stowage) Patterns.” For fresh-air exchange in marine containers, see “Trailer, Railcar and Container Design and Construction” in section I, “Important Factors in Protection of Perishable Foods”.

**CAUTION:** Ensure that the ambient air is near the product’s desired transit temperature and not so cold or hot that it will injure the product. The product may also be damaged if substantial amounts of heat or fumes from the tractor’s exhaust stack are able to enter through the front vent. When vent-cooling loads, open all available vent doors at the rear of the trailer.

## TOP-ICED LOADS

Top-icing is still applied to fresh vegetables loaded in trailers, notably broccoli, green onions, and sweet corn. See the precautions as noted under

“Refrigeration Methods — Ice” in section I, “Important Factors in Protection of Perishable Foods.”

The recommended procedure is to apply the crushed ice on top of the load in three lengthwise windrows. The thermostat should be set at 35°F (2°C) to allow the ice to melt steadily during the trip. A colder setting may crust or freeze the ice and block air circulation, thus allowing heat buildup in the interior of the load.

**CAUTION:** The load should be cooled prior to loading. Crops packed in cartons must be impervious to water. Ensure that the crushed ice is sanitary and is not cold enough to freeze the produce on contact. Ice may come out of cold storage at colder than 25°F (-4°C).

For palletized loads, the load patterns shown in Figures 38a and 38b are preferred.

---

## V. Individual Commodity Requirements

### FRESH FRUITS AND VEGETABLES

Providing maximum quality and shelf life at destination requires maintaining the recommended transport conditions. For loads with more than one commodity, consult “Load Compatibility Groups” in Appendix II.

Thermostat settings should be determined on a load-by-load basis, taking into account the operating characteristics of individual trailers, containers and railcars, the loading temperature of the product, and the desired transit temperature for the product loaded.

**CAUTION:** Be careful when determining the thermostat and ‘low temperature limit’ settings for fresh or chilled products transported at temperatures near their freezing point. Considerable freezing or chilling damage could occur, especially on the top or bottom layer of the load for top-air delivery trailers and railcars and bottom-air delivery containers, respectively. This is because air exiting the refrigeration unit may be several degrees below the thermostat setting to attain a cooling differential with the air at the return. This is especially true for products that are warmer than the desired shipping temperature at the time of loading.

The best practice to prevent product freezing is to set the thermostat for ‘discharge air control’ rather than ‘return air control’ or select a low temperature ‘floor limit’ above the freezing point of the cargo – the actual



setting chosen must be determined based on the initial product temperature and the capabilities of the transportation unit refrigeration system.

## **Alfalfa sprouts (see Sprouts)**

## **Apples**

### ***Recommended transport conditions:***

- *Desired transit temperature:*  
Most varieties: 30° to 32°F (-1° to 0°C)  
Chilling-sensitive varieties (e.g., Honeycrisp and McIntosh):  
38° to 40°F (3° to 4°C)
- *Desired relative humidity:*  
90 to 95 percent
- *Highest freezing point:*  
30.0°F (-1.1°C)

After harvest, most apples are held in bulk bins in cold storage until they are sold. As orders are received, apples are packed in fiberboard cartons. After packing, the apple cartons are palletized for transport to the loading dock.

Apples ripen steadily at temperatures above 40°F (4°C). Therefore, refrigerate them immediately after harvest. Hold and transport most varieties at the 30° to 32°F (-1° to 0°C) temperature range. Some varieties, such as Honeycrisp and McIntosh, are subject to chilling injury at long exposure to temperatures below 38°F (3°C).

Transport apples taken from cold storage at the same temperature at which they were stored. Since most apples are shipped at temperatures near their freezing point, they are quite susceptible to freezing injury. Thermostatically controlled heating should be used to prevent both freezing and overheating in extremely cold weather.

Mature apples coming from cold storage bruise more easily than those recently harvested and require more careful handling. Apples absorb odors quite readily and should generally not be shipped in vehicles harboring strong odors. Apples should not be shipped in mixed loads of commodities that include onions or potatoes, from which apples absorb odors. Also, cabbage, carrots, celery, figs, onions, and potatoes absorb odors from apples. Apples also produce ethylene, and they should not be shipped with products sensitive to this gas.

### ***Recommended loading methods:***

- *Fiberboard cartons* — Nearly all apples are shipped in fiberboard boxes. The apples may be packed in the boxes loose, in polyethylene bags, or in molded trays. The cartons are usually palletized and secured by glue, straps, or netting. Use airflow or center loading with spacer blocks for pallets in trailers; block stow individual cartons and use 9-11 loading of pallets in marine containers, being sure to use spacer blocks in units with flat walls (Figure 38).
- *Pallet bins* — Apples for processing may be shipped in bins. Do not overfill bin loads to prevent apples in the bottom bins from being bruised. Bin loading patterns are the same as for pallets (Figure 38). Take care not to block ventilation between the layers when stacking solid wall fiberboard bins.

## **Apricots**

### ***Recommended transport conditions:***

- *Desired transit temperature:*  
32°F (0°C)
- *Desired relative humidity:*  
90 to 95 percent
- *Highest freezing point:*  
30.1°F (-1.1°C)

Apricots should be partially ripe but firm when shipped and quickly precooled to the desired transit temperature using forced-air cooling, so they will have a 1- to 2-week shelf life. Apricots are ethylene producers and may be shipped with other similar tree fruit commodities from the same or nearby packing houses.

### ***Recommended loading methods:***

- *Fiberboard cartons* — Apricots are packed in cartons that are loose-filled or contain 2-layer tray packs or 'clamshell' packages. Cartons of apricots generally are unitized on pallets. Secure the cartons with straps or plastic netting. Use airflow or center loading with spacer blocks for pallets in trailers; block stow individual cartons and use 9-11 loading of pallets in marine containers, being sure to use spacer blocks in units with flat walls (Figure 38).

## Artichokes

### ***Recommended transport conditions:***

- *Desired transit temperature:*  
32°F (0°C)
- *Desired relative humidity:*  
95 to 100 percent
- *Highest freezing point:*  
29.9°F (-1.2°C)
- May be package iced or top iced

Artichokes should be cooled as soon as possible after harvest to reduce wilting, weight loss, discoloration, and decay. Best cooling methods are forced-air cooling and hydrocooling. Top-ice may be applied to minimize wilting or loss of turgidity and to keep the buds near the desired transit temperature for added shelf life. See “Ice” under “Refrigeration Methods” in section I for further information about icing. The marketability of artichokes is also reduced by bruising or freezing. Severe freezing turns the buds black and slight freezing causes skin breaks and blisters.

### ***Recommended loading methods:***

- *Waxed, fiberboard cartons* — Artichokes are mostly loose-fill packed in waxed fiberboard cartons or sometimes in tray packs that are placed into master cartons. The cartons are usually palletized and secured by glue, straps, or netting. Use airflow or center loading with spacer blocks for pallets in trailers; block stow individual cartons and use 9-11 loading of pallets in marine containers, being sure to use spacer blocks in units with flat walls (Figure 38). If package ice or top ice is used, the cartons must be moisture-resistant, and floor drains should be open so that meltwater will not accumulate on the vehicle floor.

## **Asian Vegetables (bitter melon, bok choy, Chinese broccoli, Chinese cabbage, long bean, luffa, wax gourd)**

### ***Recommended transport conditions:***

There are more than 40 vegetables used in Asian cooking, and they have a range of recommended storage conditions. Due to high perishability, they should be cooled to recommended temperature soon after harvest by hydrocooling or forced-air cooling; for leafy vegetables, vacuum cooling is also effective. Temperature-sensitive crops (bitter melon, long bean,

luffa, and wax gourd) should not be package- or top-iced. Table 6 lists recommendations for the most common Asian vegetables.

**Table 6.** Recommendations for transportation conditions and features for selected asian vegetables.

VEGETABLE	TEMPERATURE °F (°C)	RELATIVE HUMIDITY (%)	ETHYLENE SENSITIVE?	CHILLING SENSITIVE?	STORAGE LIFE
Bitter melon	50 (10)	85 to 90	Yes	Yes	2 to 3 weeks
Bok choy, pak choy	32 (0)	95 to 100	Yes	No	2 to 3 months
Chinese broccoli Gai lan	32 (0)	85 to 90	Yes	No	1 to weeks
Chinese cabbage Napa	32 (0)	95 to 100	Yes	No	2 to 3 months
Long bean	41 to 46 (5 to 7.5)	95 to 100	Yes	Yes	8 to 12 days
Luffa	50 to 54 (10 to 12)	90 to 95	Yes	Yes	2 weeks
Wax gourd	54 (12)	85 to 90	Yes	Yes	5 months

**Recommended loading methods:**

- *Waxed, fiberboard cartons* — These products are usually loose-fill packed into waxed fiberboard cartons. The cartons are usually palletized and secured by glue, straps, or netting. Use airflow or center loading with spacer blocks for pallets in trailers; block stow individual cartons and use 9-11 loading of pallets in marine containers, being sure to use spacer blocks in units with flat walls (Figure 38).

**Asparagus**

**Recommended transport conditions:**

- *Desired transit temperature:*  
32° to 35°F (0° to 2°C)
- *Desired relative humidity:*  
95 to 100 percent

- *Highest freezing point:*  
30.9°F (-0.6°C)
- *Do not top ice*

Asparagus is highly perishable and requires rapid and careful handling to minimize quality loss during transit. As soon as asparagus is cut, its natural sugars, flavor, and vitamin C begin to diminish rapidly, particularly at temperatures above 36°F (2°C). The stem becomes more fibrous with delayed cooling and exposure to ethylene. Hydrocooling is the most desirable cooling method. Imported asparagus is usually air-shipped and is forced-air cooled or hydrocooled upon arrival before further domestic transport. Asparagus is usually bunched and packed upright in pyramid-shaped packages to prevent curling of the tender tips and bruising. To reduce moisture loss and preserve crispness during shipping, pressed paperboard or other water-retaining material can be placed under the bunches.

#### ***Recommended loading methods:***

- *Waxed fiberboard cartons and plastic corrugated cartons* — Asparagus is usually bunched and packed upright in pyramid-shaped packages. The packages are usually palletized and secured by glue, straps, or netting. The slope of the pyramid-shaped containers creates air channels to facilitate cooling during shipping. Use airflow or center loading with spacer blocks for pallets in trailers; block stow individual packages and use 9-11 loading of pallets in marine containers, being sure to use spacer blocks in units with flat walls (Figure 38).

## **Avocados**

#### ***Recommended transport conditions:***

- *Desired transit temperature:*  
*Cold-tolerant varieties* (e.g., Lula, and Booth No. 8):  
40°F (4°C)  
*Intermediate varieties* (primarily Hass; also Fuerte):  
40° to 45°F (4° to 7°C), declining as the season progresses  
*Cold-intolerant varieties:* All West Indian varieties (e.g., Fuchs, Pollack, Simmonds, and Walden): 55°F (13°C)
- *Desired relative humidity:*  
85 to 90 percent
- *Highest freezing point:*  
31.5°F (-0.3°C)

Gradual ripening of avocados may occur at temperatures as low as 45°F (7°C). The rate of ripening and softening of the fruit increases as the temperature rises. Therefore, it is important to precool avocados before loading, which is usually done using forced-air cooling. Below recommended temperatures, avocados are susceptible to chilling injury. Common symptoms of chilling injury are a grayish-brown discoloration of the flesh, scalding and/or pitting of the skin, and failure of the fruit to ripen satisfactorily after storage or transit. At temperatures higher than recommended, anthracnose or black spot can become serious disorders.

Avocados should not be shipped in mixed loads that include peppers or pineapples, from which avocados absorb odors.

***Recommended loading methods:***

- *Fiberboard cartons* — Shippers use fiberboard cartons for packing avocados, predominantly one- or two-layer boxes, but also loose-filled or tight-filled cartons, and generally palletize their avocados, securing the cartons by glue, straps, or netting. Use airflow or center loading with spacer blocks for pallets in trailers; block stow individual cartons and use 9-11 loading of pallets in marine containers, being sure to use spacer blocks in units with flat walls (Figure 38).

**Bananas**

***Recommended transport conditions:***

- *Desired transit temperature:*  
56° to 58°F (13° to 14°C)
- *Desired relative humidity:*  
90 to 95 percent
- *Highest freezing point:*  
30.6°F (-0.8°C)

Bananas are imported into the United States year-round from various Central and South American countries. The Cavendish variety is most commonly imported. Bananas are shipped green and usually ripened at destination, although some-in-transit ripening is also done. They are very temperature sensitive; lower than desired temperatures will cause chilling injury, and higher than desired temperatures may cause rapid and improper ripening or 'cooking'. Proper air circulation is required to maintain uniform temperatures throughout the load, since fluctuating temperatures are detrimental. Provide a fresh air vent at minimum to prevent ethylene gas buildup inside the container or trailer or use an ethylene scrubber. Ethylene is produced by

bananas and will cause premature ripening. Also, do not ship bananas with other produce that is not temperature compatible or that produces high amounts of ethylene.

***Recommended loading methods:***

- *Fiberboard cartons* — Nearly all bananas are packed in heavy duty, plastic film-lined fiberboard cartons at the country of origin. The gross weight of the cartons is 40 pounds (18 kg). The cartons are usually palletized and secured by glue, straps, or netting. They then are transported to the United States under carefully controlled temperature and humidity conditions in refrigerated marine containers or, less commonly, on break-bulk ships.

Since bananas are easily bruised, do not throw or drop the cartons during handling. Place the cartons on their bottoms, and do not invert or stack them on their sides. Use airflow or center loading with spacer blocks for pallets in trailers; block stow individual cartons and use 9-11 loading of pallets in marine containers, being sure to use spacer blocks in units with flat walls (Figure 38). If not palletized, block stow the cartons crosswise or lengthwise and stack tightly together to get a dense load. In extremely cold weather, transfer the cartons onto floor racks or pallets in vehicles without deep T-rail floors so as to prevent freezing or chilling injury.

**Beans (green, snap, or pole)**

***Recommended transport conditions:***

- *Desired transit temperature:*  
40° to 45°F (4° to 7°C)
- *Desired relative humidity:*  
95 percent
- *Highest freezing point:*  
30.7°F (-0.7°C)
- *Do not top ice*

At temperatures above 50°F (10°C), snap (or green) beans shrivel and decay rapidly. Beans should be hydrocooled soon after harvest and may be packed wet so long as the hydrocooling water is properly sanitized and the beans are kept below 45°F. Storage life is 8 to 12 days. Snap beans are highly susceptible to chilling injury, which predisposes them to russetting and other discoloration. Temperatures from 40° to 45°F (4° to 7°C) are considered best for shipping beans, although some varieties may incur chilling injury after

several days at 45°F (7°C). Snap beans should not be shipped in mixed loads with peppers, from which snap beans absorb odors. Snap beans are sensitive to ethylene and should not be shipped with ethylene producers.

***Recommended loading methods:***

- *Waxed, fiberboard cartons and wirebound crates* — Packages for green beans are loose-filled and then usually palletized and secured by glue, straps, or netting. Use airflow or center loading with spacer blocks for pallets in trailers; block stow individual cartons or crates and use 9-11 loading of pallets in marine containers, being sure to use spacer blocks in units with flat walls (Figure 38).

**Beans (lima, in pods)**

***Recommended transport conditions:***

- *Desired transit temperature:*  
41° to 43°F (5° to 6°C)
- *Desired relative humidity:*  
95 percent
- *Highest freezing point:*  
31°F (-0.6°C)
- *Do not top ice*

Fresh lima beans in pods are very perishable and should be hydrocooled as soon as possible after harvest to minimize moisture loss. They will keep from 5 to 7 days if held and shipped within the desired temperature range. Higher holding temperatures will greatly reduce the market life of the beans, while storage below this range can lead to chilling injury which appears as rusty-brown specks on the pods. Lima beans are sensitive to ethylene and should not be shipped with ethylene producers.

***Recommended loading methods:***

- *Waxed, fiberboard cartons and wirebound crates* — Packages for lima beans are loose-filled and then usually palletized and secured by glue, straps, or netting. Use airflow or center loading with spacer blocks for pallets in trailers; block stow individual cartons or crates and use 9-11 loading of pallets in marine containers, being sure to use spacer blocks in units with flat walls (Figure 38).

**Bean sprouts (see Sprouts)**



## Beets

### ***Recommended transport conditions:***

- *Desired transit temperature:*  
32°F (0°C)
- *Desired relative humidity:*  
98 to 100 percent
- *Highest freezing point*  
Tops, 31.3°F (-0.4°C)  
Roots, 30.3°F (-0.9°C)
- *May be top iced*

Beets are very susceptible to moisture loss. Without tops they are loosely packed, and with tops they are bunched. The leaves of bunched beets are especially susceptible to mechanical damage which promotes bacterial soft rot. Those shipped in bunches are highly perishable because of the heat generated by the tops. Rapid removal of field heat is best accomplished by package-icing or hydrocooling, which minimize moisture loss and growth of soft rot bacteria. Late-crop beets are topped and may be shipped immediately or stored for later shipment. They are fairly decay-resistant as long as their skins are not broken and recommended storage conditions are maintained. However, package-icing is recommended for long-distance shipments in hot weather; top-icing may also be applied. See “Ice” under “Refrigeration Methods” in section I for further information about icing.

### ***Recommended loading methods:***

- *Waxed, fiberboard cartons or wirebound crates* — Packages for beet roots without tops are loose-filled; beets with tops are bunched and the bunches place-packed into the packages. The packages are usually palletized and secured by glue, straps, or netting. Use airflow or center loading with spacer blocks for pallets in trailers; block stow individual cartons or crates and use 9-11 loading of pallets in marine containers, being sure to use spacer blocks in units with flat walls (Figure 38). If top ice is used, the cartons must be moisture-resistant, and floor drains should be open so that meltwater will not accumulate on the vehicle floor.

### **Beet Tops (see Greens)**

## **Blackberries**

### ***Recommended transport conditions:***

- *Desired transit temperature:*  
31° to 32°F (-0.6o to 0°C)
- *Desired relative humidity:*  
90 to 95 percent
- *Highest freezing point:*  
30.5°F (-0.8°C)

Blackberries are extremely perishable, being highly susceptible to mechanical damage and fungal decays. To minimize bruising, they are typically field-packed into rigid, vented ‘clamshell’ packages in single-layer cartons (‘flats’). Blackberries should be forced-air cooled as close to 32°F (0°C) as possible within 2 hours of harvest. Under the very best conditions their market life is no more than 7 days. Only sound fruit should be shipped, because decay fungi easily spread from fruit to fruit. Truck shipments of blackberries may be mixed loads with raspberries and strawberries, which have similar packaging and transit requirements. Blackberries are subject to various types of mold, which can be controlled most effectively by rapidly precooling and holding the berries at the desired 32°F (0°C) temperature immediately after harvest.

### ***Recommended loading methods:***

- *Open-top fiberboard tray cartons* — Virtually all blackberries are picked into rigid, vented ‘clamshell’ packages packed into single-layer cartons. The packages are palletized and tabs in the cartons serve to interlock the layers. Sheets are inserted between the layers during stacking to further solidify the pallet. Strap the flats securely to the pallets to minimize bouncing and rotating of the berries from highway shock and vibration, a major cause of physical damage to berries during transit. Use airflow or center loading with spacer blocks for pallets in trailers; use 9-11 loading of pallets in marine containers, being sure to use spacer blocks in units with flat walls (Figure 38). For additional protection against decay and to extend shelf life, some loads of blackberries may have airtight plastic bags sealed over the pallets that have been injected with 10 to 20% carbon dioxide (CO<sub>2</sub>) (Figure 42).



**Figure 42.** A pallet of blueberries, enclosed in an airtight plastic bag and injected with a modified atmosphere. (Source: S. Sargent)

## Blueberries

### ***Recommended transport conditions:***

- *Desired transit temperature:*  
31° to 32°F
- *Desired relative humidity:*  
90 to 95 percent
- *Highest freezing point:*  
29.7°F (-1.3°C)

Blueberries are very temperature sensitive. Temperatures much above the desired holding temperature cause over-ripening, shriveling, and loss of shelf life. Avoid moisture on berries caused by condensation or other sources, while in transit. A minimum of handling, close temperature control, and expedited shipment and marketing are essential for successful sales since blueberries have a shelf life of only about 2 weeks under optimum conditions. Modifying the atmosphere with CO<sub>2</sub> in conjunction with refrigeration is effective in retarding decay in blueberries, but may result in off-flavors.

### ***Recommended Loading Methods:***

- *Fiberboard Trays* — Blueberries are packed in several sizes of vented ‘clamshell’ packages. A common pack consists of twelve clamshells that

are packed in two layers of six clamshells each in a fiberboard tray ('flat'). The trays are nearly always palletized for shipment and secured by glue, straps, or netting. Use airflow or center loading with spacer blocks for pallets in trailers; use 9-11 loading of pallets in marine containers, being sure to use spacer blocks in units with flat walls (Figure 38). For additional protection against decay and to extend shelf life, some loads of blueberries may have airtight plastic bags sealed over the pallets that have been injected with 10 to 20% carbon dioxide (CO<sub>2</sub>) (Figure 42).

## Broccoli

### **Recommended transport conditions:**

- *Desired transit temperature:*  
32°F (0°C)
- *Desired relative humidity:*  
95 to 100 percent
- *Highest freezing point:*  
30.9°F (-0.6°C)
- *Package ice desirable; may be top iced*

The respiration rate of broccoli is among the highest for vegetables. Therefore, it is precooled by hydrocooling or package icing soon after harvest. See "Ice" under "Refrigeration Methods" in section I for further information about icing. Broccoli florets (buds) are very susceptible to yellowing and reduced marketability with even short exposure to temperatures above 50°F (10°C). Broccoli is very sensitive to ethylene gas and should not be shipped with ethylene producers, such as apples or pears. During shipping, fresh air exchange in the trailer is recommended to prevent depletion of oxygen that leads to development of undesirable odors.

### **Recommended loading methods:**

- *Waxed, fiberboard cartons* — Broccoli is usually handled as bunches or crowns packed loose in waxed, fiberboard cartons with crushed ice or overwrapped with shrink wrap without ice following hydrocooling. Consumer packs of florets, bunch, broccoli coleslaw, spears and stalk cuts are packed in unwaxed, fiberboard cartons. The cartons are usually palletized and secured by glue, straps, or netting. After the pallets are loaded, the load can be top iced. See "Ice" under "Refrigeration Methods" in section I for further information about icing. If package ice or top ice is used, the cartons must be moisture-resistant, and floor drains should be open so that meltwater will not accumulate on the vehicle floor. Note: If

shrink film is used to secure the pallet loads, make sure the film does not cover the top, so melt-water can filter down through the broccoli during shipping. Use airflow or center loading with spacer blocks for pallets in trailers; block stow individual cartons and use 9-11 loading of pallets in marine containers, being sure to use spacer blocks in units with flat walls (Figure 38).

## **Brussels Sprouts**

### ***Recommended transport conditions:***

- *Desired transit temperature:*  
32°F (0°C)
- *Desired relative humidity:*  
95 to 100 percent
- *Highest freezing point:*  
30.5°F (-0.8°C)
- *May be package iced or top iced*

Keep Brussels sprouts near the desired 32°F (0°C) for maximum shelf life of 3 to 5 weeks. At 41°F (5°C) the deterioration rate of Brussels sprouts doubles. Do not ship them with ethylene-producing fruit, because Brussels sprouts will yellow. Use perforated plastic package liners to help prevent moisture loss from transpiration. A controlled or modified atmosphere of 2.5% to 5% oxygen and 5% to 7.5% carbon dioxide helps maintain the quality of Brussels sprouts at 41°F (5°C) or 50°F (10°C), but not at 32°F.

### ***Recommended loading methods:***

- *Waxed, fiberboard cartons* — Brussels sprouts are shipped mostly in waxed, fiberboard cartons. Loose-filled cartons often include package ice or top ice. The cartons are usually palletized and secured by glue, straps, or netting. After the pallets are loaded, the load may be top iced. See “Ice” under “Refrigeration Methods” in section I for further information about icing. If package ice or top ice is used, the cartons must be moisture-resistant, and floor drains should be open so that meltwater will not accumulate on the vehicle floor. Note: If shrink film is used to secure the pallet loads, make sure the film does not cover the top, so meltwater can filter down through the Brussels sprouts during shipping. Brussels sprouts may also be packed in plastic bags or ‘clamshells’ in unwaxed cartons. Use airflow or center loading with spacer blocks for pallets in trailers; block stow individual cartons and use 9-11 loading of pallets in

marine containers, being sure to use spacer blocks in units with flat walls (Figure 38).

## **Cabbage**

### ***Recommended transport conditions:***

- *Desired transit temperature:*  
32°F (0°C)
- *Desired relative humidity:*  
98 to 100 percent
- *Highest freezing point:*  
30.4°F (-0.9°C)
- *Do not top ice*

Although cabbage is less perishable than many other leafy vegetables, it should be cooled soon after harvest by room cooling, hydrocooling, or forced-air cooling. Wilting from moisture loss is the main cause of damage during handling and transporting. With adequate cooling and ventilation, cabbage can be stored up to 6 months. Stored cabbage is less likely to wilt during transit than new cabbage. Except for a few new crop shippers, most shippers do not top ice cabbage. Stored cabbage should not be top iced. Several kinds of decay, such as bacterial soft rot and watery soft rot, may damage cabbage during transit if the desired temperature is not maintained. Cabbage should not be shipped in mixed loads of commodities that include apples or pears, from which cabbage absorbs odors.

### ***Recommended loading methods:***

- *Crates, fiberboard cartons and mesh bags* — Cabbage is shipped in crates, cartons or mesh sacks that are usually palletized and secured by glue, straps, or netting. Use airflow or center loading with spacer blocks for pallets in trailers; block stow individual cartons and use 9-11 loading of pallets in marine containers, being sure to use spacer blocks in units with flat walls (Figure 38).
- *Pallet bins* — Cabbage is shipped in bulk bins for processing. Do not overfill bin loads to prevent heads in the bottom bins from being bruised or crushed. Bin loading patterns are the same as for pallets (Figure 38). Take care not to block ventilation between the layers when stacking solid wall fiberboard bins.

## Cactus stems (nopalitos)

### **Recommended transport conditions:**

- *Desired transit temperature:*  
41°F (5°C)
- *Desired relative humidity:*  
85 to 90 percent
- *Highest freezing point:*  
28.9°F (-1.8°C)

Cactus stems are harvested at a tender stage and spines are removed. They should be cooled quickly to minimize moisture loss, which is the major limitation to storage life.

### **Recommended loading methods:**

- *Fiberboard cartons* — The cartons are usually palletized and secured by glue, straps, or netting. Use airflow or center loading with spacer blocks for pallets in trailers; block stow individual cartons and use 9-11 loading of pallets in marine containers, being sure to use spacer blocks in units with flat walls (Figure 38).

## Cantaloupes (muskmelons)

### **Recommended transport conditions:**

- *Desired transit temperature:*  
36° to 41°F (2° to 5°C)
- *Desired relative humidity:*  
95 percent
- *Highest freezing point:*  
29.9°F (-1.2°C)
- *May be package-iced or top iced*

After harvest, cantaloupes are quickly cooled by forced-air cooling, hydrocooling or package icing. This slows ripening and maintains firmness during long-distance transport. Although they are chill-sensitive, cantaloupes are not harmed by extended contact with ice. The load may be top iced if the cantaloupes are packed in moisture-resistant cartons. See “Ice” under “Refrigeration Methods” in section I for further information about icing.

Cantaloupes picked at the hard-ripe stage of maturity are subject to chilling injury if held at temperatures below 36°F (2.2°C) for longer than 1 week. For normal truck shipments of less than 1 week, temperatures between 32° and 34°F (0° to 1°C) will not be harmful. Cantaloupes produce ethylene, so do not ship in mixed loads with ethylene-sensitive crops such as leafy greens.

**Recommended loading methods:**

- *Fiberboard cartons* — Cantaloupes may be loose-filled or place-packed into waxed fiberboard cartons. The cartons are usually palletized and secured by glue, straps, or netting. If package ice or top ice is used, the cartons must be moisture-resistant, and floor drains should be open so that meltwater will not accumulate on the vehicle floor. Use airflow or center loading with spacer blocks for pallets in trailers; block stow individual cartons and use 9-11 loading of pallets in marine containers, being sure to use spacer blocks in units with flat walls (Figure 38).

**Carambola (Starfruit)**

**Recommended transport conditions:**

- *Desired transit temperature:*  
41° to 50°F (5° to 10°C)
- *Desired relative humidity:*  
85 to 90 percent
- *Highest freezing point:*  
30.0°F (-1.1°C) (estimated)

Carambola should be harvested at ¼ to ½ yellow color and should be quickly pre-cooled using forced-air cooling to the desired transit temperature, so they will have a 3- to 4-week shelf life. Green carambolas have poor eating quality and are more susceptible to chilling injury than partially ripe fruit, which causes small surface pits to form. Carambolas are easily damaged and should be packed with padding to immobilize and protect the fruit. Lower than recommended RH causes desiccation and rib-edge browning.

**Recommended loading methods:**

- *Fiberboard cartons* — Carambolas are usually packed standing on end in a single layer in fiberboard cartons with foam mesh sleeves around individual fruit and a foam pad placed beneath the fruit or with cardboard dividers to separate the fruit. Carambolas may also be loose-filled into fiberboard cartons. Cartons of carambolas generally are unitized on pallets and secured by glue, straps, or plastic netting. Use airflow or center loading with spacer blocks for pallets in trailers; block stow



individual cartons and use 9-11 loading of pallets in marine containers, being sure to use spacer blocks in units with flat walls (Figure 38).

## Carrots

### **Recommended transport conditions:**

- *Desired transit temperature:*  
32°F (0°C)
- *Desired relative humidity:*  
98 to 100 percent
- *Highest freezing point:*  
29.5°F (-1.4°C)
- *May be top iced*

Carrots may be packed un-topped or bunched. Carrots with tops are very sensitive to drying and require extra care during handling and packing to minimize mechanical damage to the tops. Hydrocool carrots after harvest; topped carrots can be top iced to help retain moisture and reduce shriveling. See “Ice” under “Refrigeration Methods” in section I for further information about icing. Under proper conditions, topped carrots will keep up to 4 months and bunched carrots up to 2 weeks.

Topped carrots are shipped to market loose in bulk bags or fiberboard cartons or packed in consumer-size plastic bags within larger mesh bags or in waxed, fiberboard cartons. Carrots should not be shipped in mixed loads of commodities that include apples or pears, from which carrots absorb odors. Also, celery absorbs odors from carrots. Do not ship carrots with ethylene-producing commodities, because this will cause the carrots to develop a bitter flavor.

### **Recommended loading methods:**

- *Waxed, fiberboard cartons* — Carrots are usually packed horizontally in fiberboard cartons. The cartons are usually palletized and secured by glue, straps, or plastic netting. Use airflow or center loading with spacer blocks for pallets in trailers; block stow individual cartons and use 9-11 loading of pallets in marine containers, being sure to use spacer blocks in units with flat walls (Figure 38). If top ice is used, the cartons must be moisture-resistant, and floor drains should be open so that meltwater will not accumulate on the trailer floor.
- *Open mesh or plastic film bags* — Carrots in bags usually are stacked so that, when loaded, the roots are in a vertical position. Wrap palletized

loads with net, or strap for stability. Use airflow or center loading with spacer blocks for pallets in trailers; use 9-11 loading of pallets in marine containers, being sure to use spacer blocks in units with flat walls (Figure 38). Sacks or bags of carrots may be shipped in railcars with no specific loading pattern, but it is not a recommended practice. If top ice is used, the floor drains should be open so that meltwater will not accumulate on the railcar floor.

## **Cassava**

### ***Recommended transport conditions:***

- *Desired transit temperature:*  
32°F (0°C)
- *Desired relative humidity:*  
85 to 90 percent
- *Highest freezing point:*  
29.5°F (-1.4°C)

Cassava (yuca) is a starchy root shipped from tropical production regions. It is shipped fresh for tablestock use and is prepared similar to potatoes. Fresh cassava is a very perishable crop for two reasons. It is extremely turgid; therefore, great care needs to be taken during harvest to minimize cracking of the peel, which leads to water loss and decay. Secondly, when held under ambient conditions, shelf life is limited to 2 or 3 days due to development of a dark blue pigment in the flesh, known as vascular streaking. For export, shelf life can be extended to 21 days or more by washing and rinsing, followed by applying a paraffin wax (food grade) coating and room cooling to 32° to 41°F (0° to 5°C). It is sensitive to exposure to ethylene.

### ***Recommended loading methods:***

- *Fiberboard cartons* — Cassava is shipped in loose-filled fiberboard cartons with the roots all oriented in the same direction. The cartons are usually palletized and secured by glue, straps, or plastic netting. Use airflow or center loading with spacer blocks for pallets in trailers; block stow individual cartons and use 9-11 loading of pallets in marine containers, being sure to use spacer blocks in units with flat walls (Figure 38).

## Cauliflower

### **Recommended transport conditions:**

- *Desired transit temperature:*  
32°F (0°C)
- *Desired relative humidity:*  
95 to 98 percent
- *Highest freezing point:*  
30.6°F (-0.8°C)
- *May be top iced*

Cauliflower is very sensitive to mechanical damage, which causes discoloration of the white buds. They must be carefully handled during packing, loading and handling. Cauliflower is typically vacuum cooled or hydrocooled as soon as possible after harvest. With proper shipping, it has up to 4 weeks shelf life. It is very sensitive to ethylene and should not be shipped with ethylene-producing crops.

### **Recommended loading methods:**

- *Waxed, fiberboard cartons and wirebound crates* — Cauliflower heads are typically overwrapped and packed into waxed fiberboard cartons or wirebound crates. The cartons are usually palletized and secured by glue, straps, or plastic netting. Use airflow or center loading with spacer blocks for pallets in trailers; block stow individual cartons and use 9-11 loading of pallets in marine containers, being sure to use spacer blocks in units with flat walls (Figure 38). If top ice is used, the cartons must be moisture-resistant, and floor drains should be open so that meltwater will not accumulate on the vehicle floor.
- *Pallet bins* — Cauliflower is shipped in bulk bins with slatted sides to allow removal of respiratory heat. Bin loading patterns are the same as for pallets (Figure 38). Do not overfill bin loads to prevent heads in the bottom bins from being bruised or crushed. If top ice is used, the floor drains should be open so that meltwater will not accumulate on the trailer floor.

## Celery

### **Recommended transport conditions:**

- *Desired transit temperature:*  
32°F (0°C)

- *Desired relative humidity:*  
98 to 100 percent
- *Highest freezing point:*  
31.1°F (-0.5°C)
- *May be top iced*

After harvest celery continues to grow, so pack it upright in the package. Sometimes celery is sleeved or bagged at the shipping point. The sleeves help retain moisture and reduce wilting which is a main cause of deterioration. Soon after harvest, cool celery to below 40°F (4°C) by either hydrocooling or hydro-vacuum cooling to maintain crispness and limit decay. Top-icing may be applied to un-sleeved celery packed in moisture-resistant cartons or crates, but this practice is not necessary if the celery is sleeved. See “Ice” under “Refrigeration Methods” in section I for further information about icing. Celery should not be shipped in mixed loads of commodities that include onions, apples or pears, from which celery absorbs odors. Also, carrots and onions absorb odors from celery. Do not ship celery with ethylene-producing commodities, because ethylene accelerates yellowing of the celery, especially the leaves. With proper handling, celery should remain in good condition for 1 to 3 months.

***Recommended loading methods:***

- *Fiberboard cartons* — Celery is packed in fiberboard cartons, either naked or in plastic film sleeves, with the bunches all oriented in the same direction. The cartons are usually palletized and secured by glue, straps, or plastic netting. Use airflow or center loading with spacer blocks for pallets in trailers; block stow individual cartons and use 9-11 loading of pallets in marine containers, being sure to use spacer blocks in units with flat walls (Figure 38). If top ice is used, the cartons must be moisture-resistant, and floor drains should be open so that meltwater will not accumulate on the vehicle floor.

**Chayote squash**

***Recommended transport conditions:***

- *Desired transit temperature:*  
41° to 50°F (5° to 10°C)
- *Desired relative humidity:*  
85 to 95 percent

- *Highest freezing point:*  
31.1°F (-0.5°C)
- *Do not top ice*

Chayote squash has tender skin, and fruit may be individually wrapped in plastic bags or tissue paper to minimize abrasion during shipping. They can be stored from 4 to 6 weeks under recommended conditions.

***Recommended loading methods:***

- *Waxed, fiberboard tray cartons* — Chayotes are packed in a single-layer in cartons. Wrap palletized loads with net, or strap for stability. Use airflow or center loading with spacer blocks for pallets in trailers; block stow individual cartons and use 9-11 loading of pallets in marine containers, being sure to use spacer blocks in units with flat walls (Figure 38).

**Cherries**

***Recommended transport conditions:***

- *Desired transit temperature:*  
Sweet cherries: 30° to 32°F (-1° to 0°C)  
Sour cherries: 32°F (0°C)
- *Desired relative humidity:*  
90 to 95 percent
- *Highest freezing point:*  
Sweet cherries: 28.8°F (-1.8°C)  
Sour cherries: 29.0°F (-1.7°C)

Cherries are highly perishable, so precool to the desired transit temperature using forced-air cooling before loading. In conjunction with refrigeration, consider using a modified atmosphere with up to 20% CO<sub>2</sub> to maintain the quality of cherries during transit.

Some cherry shippers place the fruit in a sealed, polyethylene bag MAP liner in the box to create a modified atmosphere. Respiration of the fruit in the bag will build up a sufficient concentration of CO<sub>2</sub> to retard decay and help maintain a fresh appearance. However, the liners should be slit at destination to prevent gas buildup and off flavors from developing at higher temperatures. California shippers do not use box liners.

### **Recommended loading methods:**

- *Fiberboard cartons* — Cherries are shipped in fiberboard cartons, often with plastic film liners. The cartons may be secured to pallets with vertical and horizontal bands or plastic netting. Use airflow or center loading with spacer blocks for pallets in trailers; block stow individual cartons and use 9-11 loading of pallets in marine containers, being sure to use spacer blocks in units with flat walls (Figure 38). For additional protection against decay and to extend shelf life, some loads of cherries may have airtight plastic bags sealed over the pallets that have been injected with 10 to 20% carbon dioxide (CO<sub>2</sub>) modified atmosphere (Figure 42). Do not combine this pallet MAP with in-carton MAP because the resulting combined atmosphere will likely damage the cherries.

### **Collard greens (see Greens)**

### **Corn (see Sweet corn)**

### **Cranberries**

#### **Recommended transit conditions:**

- *Desired transit temperature:*  
36° to 40°F (2° to 4°C)
- *Desired relative humidity:*  
90 to 95 percent
- *Highest freezing point:*  
30.4°F (-0.9°C)

Cranberries are primarily grown in Wisconsin, Massachusetts, New Jersey, Oregon, and Washington, and are harvested and available for fresh distribution from September through December. Cranberries can be held at temperatures of 36° to 40°F (2° to 4°C) up to 4 months. Cranberries will tolerate temperatures as low as 32°F (0°C) for up to 2 weeks. However, exposure for longer periods could cause chilling damage resulting in discoloration and rubbery texture. Handle cranberries with care since they are susceptible to bruising. Precool cranberries to near 40°F (4°C) before loading, because the insulation effect of the packaging makes it difficult to lower temperature during transit.

#### **Recommended loading methods:**

- *Fiberboard master cartons* — Cranberries for the fresh market are packed in 1-lb (0.45-kg) film bags or window cartons and shipped in master fiberboard cartons that will hold 24, 1-lb packages. The cartons

are palletized and secured by glue, straps, or plastic netting. Use airflow or center loading with spacer blocks for pallets in trailers; block stow individual cartons and use 9-11 loading of pallets in marine containers, being sure to use spacer blocks in units with flat walls (Figure 38).

## Cucumbers

### **Recommended transport conditions:**

- *Desired transit temperature:*  
50° to 55°F (10° to 13°C)
- *Desired relative humidity:*  
95 percent
- *Highest freezing point:*  
31.1°F (-0.5°C)
- *Do not top ice*

Cucumbers are very susceptible to moisture loss and are generally waxed prior to hydrocooling or forced-air cooling. By following recommended shipping conditions, these immature fruits have up to 14 days shelf life. Yellowing is a symptom of poor temperature management or exposure to ethylene gas if stored or shipped in mixed loads with tomatoes or other ethylene-producing crops. Cucumbers are subject to chilling injury if held or transported for longer than 2 days at temperatures below 50°F (10°C); symptoms are water-soaked areas, surface pitting and decay.

### **Recommended loading methods:**

- *Waxed, fiberboard cartons* — Most cucumbers are packed in various sizes of loose-filled waxed, fiberboard cartons. The cartons are usually palletized and secured by glue, straps, or plastic netting. Use airflow or center loading with spacer blocks for pallets in trailers; block stow individual cartons and use 9-11 loading of pallets in marine containers, being sure to use spacer blocks in units with flat walls (Figure 38).

## Daikon (see Radishes)

## Eggplants

### **Recommended transport conditions:**

- *Desired transit temperatures:*  
46° to 54°F (8° to 12°C)

- *Desired relative humidity:*  
90 to 95 percent
- *Highest freezing point:*  
30.6°F (-0.8°C)

Some eggplant fruit are subject to chilling injury at 50°F (10°C) and below. Surface scald or bronzing and pitting are symptoms of chilling injury. Chilled eggplants are subject to *Alternaria* rot when removed from storage or transit. Chilling sensitivity varies by season of harvest, variety, and maturity. Overmature fruit harvested in the fall is less sensitive to chilling than mature fruit harvested in the summer. Mature eggplants harvested midsummer are highly susceptible to decay at temperatures higher than 54°F (12°C) and to chilling injury below 50°F (10°C). Eggplants shrivel very easily during transport and storage if the relative humidity is not kept at 90%. Eggplants should not be shipped in mixed loads with ginger, from which eggplants absorb odors.

***Recommended loading patterns:***

- *Fiberboard cartons* — Most eggplants are packed in loose-fill fiberboard cartons. The cartons are usually palletized and secured by glue, straps, or plastic netting. Use airflow or center loading with spacer blocks for pallets in trailers; block stow individual cartons and use 9-11 loading of pallets in marine containers, being sure to use spacer blocks in units with flat walls (Figure 38).

**Endive and Escarole (see Leafy Greens)**

**Fennel**

***Recommended transport conditions:***

- *Desired transit temperature:*  
32°F (0°C)
- *Desired relative humidity:*  
90 to 95 percent
- *Highest freezing point:*  
30.5°F (-0.8°C)

Edible fennel stems are very perishable. Hydrocooling is recommended to minimize water loss, but excess water must be removed prior to careful packing in plastic sleeves in cartons. Under proper conditions, shelf life is 14 days.



**Recommended loading methods:**

- *Fiberboard cartons* — Fennel is packed in loose-fill fiberboard cartons. The cartons are usually palletized and secured by glue, straps, or plastic netting. Use airflow or center loading with spacer blocks for pallets in trailers; block stow individual cartons and use 9-11 loading of pallets in marine containers, being sure to use spacer blocks in units with flat walls (Figure 38).

**Figs****Recommended transport conditions:**

- *Desired transit temperature:*  
30° to 32°F (-1° to 0°C)
- *Desired relative humidity:*  
90 to 95 percent
- *Highest freezing point:*  
27.0°F (-2.8°C)

Figs should be fully ripe when harvested and quickly precooled to the desired transit temperature using forced-air cooling, so they will have a 1- to 2-week shelf life. Figs should not be shipped in mixed loads of commodities that include green onions, leeks, apples or pears, from which figs absorb odors.

**Recommended loading methods:**

- *Fiberboard cartons* — Figs are packed in cartons that contain 2-layer tray packs or ‘clamshell’ packages. Cartons of figs generally are unitized on pallets and secured by glue, straps, or plastic netting. Use airflow or center loading with spacer blocks for pallets in trailers; block stow individual cartons and use 9-11 loading of pallets in marine containers, being sure to use spacer blocks in units with flat walls (Figure 38).

**Fresh-cut Fruits and Vegetables****Recommended transport conditions:**

- *Desired transit temperature:*  
32° to 40°F (0° to 4°C)
- *Desired relative humidity:*  
90 to 95 percent

- **Highest freezing point:**

Lettuce and leafy greens; immature fruit vegetables: 31.7°F (-0.2°C)

Fruits and melons: 30.5°F (-0.8°C)

Fresh-cut fruits and vegetables are extremely perishable and must be handled at below 41°F (5°C) at all times, from the time of processing through to the retail display without any breaks in the cold chain in order to maintain quality and to avoid proliferation of food safety-related microorganisms. Almost all fresh-cut products are packed in modified atmosphere packaging (MAP) to maintain reduced oxygen and sometimes also elevated carbon dioxide in order to further slow the product deterioration rate beyond that achieved by low temperatures. The atmospheres in MAP can become injurious to the fresh-cut products if the temperature is allowed to increase above the target range of 32° to 40°F (0° to 4°C). If the seal on MAP is compromised or the package is punctured, the atmosphere will be lost and product deterioration will occur much more rapidly. Ethylene may also enter the compromised package and cause yellowing of green vegetables and russet spotting of lettuce. When properly handled in MAP, fresh-cut products typically have a shelf life of 10 to 14 days.

**Recommended loading methods:**

- *Fiberboard cartons* — Fresh-cut products are packaged in sealed, plastic consumer or institutional size plastic bags and ‘clamshells’ that are packed into fiberboard cartons. The cartons are usually palletized and secured by glue, straps, or plastic netting. Use airflow or center loading with spacer blocks for pallets in trailers; block stow individual cartons and use 9-11 loading of pallets in marine containers, being sure to use spacer blocks in units with flat walls (Figure 38).

**Garlic (dry)**

**Recommended transport conditions:**

- *Desired transit temperature:*  
32° to 34°F (0° to 1°C)
- *Desired relative humidity:*  
65 to 70 percent
- *Highest freezing point:*  
30.5°F (-0.8°C)
- *Do not top ice*

Garlic cloves are harvested when dry and can be stored under dry, ambient temperatures from 1 to 2 months; however, storage life is limited due to rapid sprouting at temperatures above 40°F (4°C). Under ideal storage conditions at 32°F (0°C) and low relative humidity, the cloves can be held up to 9 months. Garlic is usually shipped from storage. It should be loaded from refrigerated loading docks to avoid moisture condensation which will promote decay. Garlic should not be shipped in mixed loads with odor-absorbing commodities.

***Recommended loading methods:***

- *Fiberboard cartons* — Garlic is packed in loose-fill fiberboard cartons. The cartons are usually palletized and secured by glue, straps, or plastic netting. Use airflow or center loading with spacer blocks for pallets in trailers; block stow individual cartons and use 9-11 loading of pallets in marine containers, being sure to use spacer blocks in units with flat walls (Figure 38).

**Ginger**

***Recommended transport conditions:***

- *Desired transit temperature:*  
54° to 57°F (12° to 14°C)
- *Desired relative humidity:*  
85 to 90 percent
- *Highest freezing point:*  
30.5°F (-0.8°C)
- *Do not top ice*

Ginger rhizomes are dug after the plants die. They are moderately perishable and can be either forced-air cooled or room cooled, with expected storage life of 30 to 60 days. Storage at lower relative humidity will cause severe dehydration. Contact with free moisture must be avoided to minimize decay. Do not load ginger with eggplants, since eggplants will absorb the ginger odor.

***Recommended loading methods:***

- *Fiberboard cartons* — Ginger is packed in several sizes of film-lined, loose-fill fiberboard cartons. The cartons are usually palletized and secured by glue, straps, or plastic netting. Use airflow or center loading with spacer blocks for pallets in trailers; block stow individual cartons and

use 9-11 loading of pallets in marine containers, being sure to use spacer blocks in units with flat walls (Figure 38).

## Grapefruit

### ***Recommended transport conditions:***

- *Desired transit temperatures:*
  - Arizona and California: 58° to 60°F (14° to 16°C)
  - Florida and Texas:
    - From start of season to December 31 — 60°F (16°C)
    - From January 1 to end of season — 50°F (10°C)
- *Desired relative humidity:*
  - 85 to 95 percent
- *Highest freezing point:*
  - 30.0°F (-1.1°C)

Grapefruit is very susceptible to chilling injury, particularly early in the season; chilling susceptibility decreases in mid- and late-season fruit. Chilling injury symptoms are pitting or physiological breakdown on the surface of the fruit, which can be a means of entry for decay organisms. Many types of decay organisms can attack grapefruit, particularly during early- and late-season shipments. Most shippers treat their grapefruit with approved fungicides. Curing or preconditioning grapefruit can counteract some of the adverse effects of low temperature. To cure grapefruit, hold at 60°F (16°C) for 1 week. After curing, store or ship grapefruit at temperatures of 32° to 34°F (0° to 1°C) for up to 21 days. Cured grapefruit may be stored or shipped with oranges at low temperatures.

Ventilate grapefruit loads during transit in cool weather. However, during warm weather, refrigerate the loads.

**CAUTION:** 41°F (5°C) is the temperature at which the danger of chilling injury to grapefruit is the greatest.

Citrus fruits absorb odors quite readily and should not be shipped in mixed loads with any strongly scented vegetable, or vehicles harboring strong odors in general. In particular, citrus should not be shipped in mixed loads with onions, from which citrus fruit are known to absorb odors.

### ***Recommended loading methods:***

- *Fiberboard cartons* — Grapefruit may be packed in loose-fill or bag-master fiberboard cartons. The cartons are usually palletized and secured by glue, straps, or plastic netting. Take care that proper

precooling has been done when transporting grapefruit in bag masters. It is more difficult to manage the fruit temperature in transit when grapefruit are packed in polyethylene film or mesh bags and packed in cartons. Use airflow or center loading with spacer blocks for pallets in trailers; block stow individual cartons and use 9-11 loading of pallets in marine containers, being sure to use spacer blocks in units with flat walls (Figure 38).

## Grapes

### **Recommended transport conditions:**

- *Desired transit temperatures:*
  - American types — Catawba, Concord, etc.: 32°F (0°C)
  - European types (vinifera) — Thompson Seedless, Red Emperor, etc.: 31°F (-0.5°C)
- *Desired relative humidity:*
  - American: 90 to 95 percent
  - European: 85 percent
- *Highest freezing point:*
  - American types: 29.7°F (-1.3°C)
  - European types (vinifera): 28.1°F (-2.2°C)

Precool grapes to their desired transit temperature before loading using forced-air cooling and maintain the temperature during transit. Normally, fumigate vinifera grapes with sulfur dioxide (SO<sub>2</sub>) gas during storage and before shipment to control the spread of Botrytis (gray mold) and Cladosporium decays. Sulfur dioxide will not kill infections that started before harvest. For grapes that are packed for export, use top cushion pads that contain sodium bi-sulfite, which will slowly release SO<sub>2</sub> gas during transport. Do not ship grapes treated with SO<sub>2</sub> with other products, since the gas odor may be absorbed and may injure (i.e., bleach) other crops.

Do not ship grapes with green onions or leeks, as the grapes may absorb the leek and onion odors.

**WARNING:** When using SO<sub>2</sub> gas, take care to prevent injury to workers and equipment. Sulfur dioxide fumes are toxic to humans and will corrode certain metals.

### **Recommended loading methods:**

- *Wood and kraft veneer, fiberboard, and polystyrene foam cartons* — Grapes are packed in a number of different packages and bunches are

often in plastic bags within the cartons. The cartons are usually palletized and secured by glue, straps, or plastic netting. Take care that proper precooling has been done when transporting bagged grapes in cartons. It is more difficult to manage the fruit temperature in transit when grapes are packed in plastic bags and packed in cartons. Use airflow or center loading with spacer blocks for pallets in trailers; block stow individual cartons and use 9-11 loading of pallets in marine containers, being sure to use spacer blocks in units with flat walls (Figure 38).

## **Green Onions (see Onions)**

### **Greens (beet tops, collards, kale, mustard, turnip tops)**

#### ***Recommended transport conditions:***

- *Desired transit temperature:*  
32°F (0°C)
- *Desired relative humidity:*  
95 to 100 percent
- *Highest freezing point:*  
31.1°F (-0.5°C)
- *Package ice desirable; top ice is OK*

Greens have a high respiration rate and have longest storage life when quickly cooled and held at 32°F (0°C) in combination with high humidity to maintain crispness and to retard spoilage. They are usually hydrocooled or vacuum-cooled. Greens are usually ordered in small lots and shipped in mixed loads with other commodities. These crops are very sensitive to ethylene, so do not ship with ethylene-producing crops.

#### ***Recommended loading methods:***

- *Fiberboard cartons (waxed) and wirebound crates* — Greens are often bunched but may be packed loose in waxed fiberboard cartons or wooden crates. The packages are usually palletized and secured by glue, straps, or plastic netting. Use airflow or center loading with spacer blocks for pallets in trailers; block stow individual cartons or crates and use 9-11 loading of pallets in marine containers, being sure to use spacer blocks in units with flat walls (Figure 38). If package ice or top ice is used, the cartons must be moisture-resistant, and floor drains should be open so that meltwater will not accumulate on the vehicle floor.

## Guava

### **Recommended transport conditions:**

- *Desired transit temperature:*  
41° to 50°F (5° to 10°C)
- *Desired relative humidity:*  
90 to 95 percent
- *Highest freezing point:*  
30.5°F (-0.8°C)

Guavas are able to ripen after harvest and may be marketed from mature-green (color change from dark to light green) to fully-ripe (yellow). The fruit are susceptible to chilling injury, with the sensitivity to low temperature declining as the fruit ripen: mature-green or partially-ripe guavas can be stored and transported for 2 to 3 weeks at 46° to 50°F (8° to 10°C), while fully-ripe fruit can be stored and transported for 1 week at 41° to 46°F (5° to 8°C). Symptoms of chilling injury include ripening inhibition, browning of the flesh and skin, and increased decay.

### **Recommended loading methods:**

- *Fiberboard cartons* — Guavas are packed in a single layer in plastic-lined fiberboard cartons ('flats') with plastic trays that have cells to hold individual fruit. The cartons are usually palletized and secured by glue, straps, or plastic netting. Use airflow or center loading with spacer blocks for pallets in trailers; use 9-11 loading of pallets in marine containers, being sure to use spacer blocks in units with flat walls (Figure 38).

## **Herbs (fresh) (basil, chives, coriander, dill, marjoram, mint, oregano, parsley, rosemary, sage, thyme)**

### **Recommended transport conditions:**

- *Desired transit temperature:*  
Basil: 54°F (12°C)  
Other herbs: 32°F (0°C)
- *Desired relative humidity:*  
90 to 95 percent
- *Highest freezing point:*  
30.5°F (-0.8°C)

Fresh (culinary) herbs are high-value crops and require careful handling and temperature management. They should be cooled as soon after harvest

as possible with forced-air cooling or vacuum cooling to retard yellowing. Of this group, basil is only herb that is chilling sensitive when stored below 54°F (12°C); symptoms of chilling injury are graying/blackening of the leaves followed by decay. The other herbs have similar storage requirements and should be cooled to and shipped at 32°F (0°F). Storage life ranges from 10 to 14 days.

***Recommended loading methods:***

- *Fiberboard cartons* — Fresh herbs may be packed in bulk in plastic-lined cartons, or they may be placed into rigid, hinged ‘clamshell’ packages or consumer sleeve packs inside larger cartons. The cartons are usually palletized and secured by glue, straps, or plastic netting. Use airflow or center loading with spacer blocks for pallets in trailers; block stow individual cartons or crates and use 9-11 loading of pallets in marine containers, being sure to use spacer blocks in units with flat walls (Figure 38).

**Horseradish**

***Recommended transport conditions:***

- *Desired transit temperature:*  
30° to 32°F (-1.1° to 0°C)
- *Desired relative humidity:*  
98 to 100 percent
- *Highest freezing point:*  
28.7°F (-1.8°C)

Horseradish roots are dug after fall chilling or freezing has occurred and usually don’t require precooling. The roots are quite susceptible to water loss, which results in limp texture similar to carrots. For best results, horseradish should be stored at 30 to 32°F (-1.1 to 0°C) with a relative humidity as near to saturation as possible to prevent loss of moisture. Horseradish can be stored for up to 1 year under these conditions. Use of perforated polyethylene bags is suggested as a method of maintaining high humidity; nylon bags are also used. Horseradish should be protected from exposure to light, as the roots will turn green and lose value, similar to potatoes.

***Recommended loading methods:***

- *Nylon or plastic bags* — Horseradish may be packed in 5 or 10 lb. perforated plastic bags that are put into 40 or 50 lb. master nylon or perforated plastic bags or they may be packed directly into the larger bags. Stack the bags lengthwise or crosswise on pallets and wrap with



net or strap to secure them to the pallet. Use airflow or center loading with spacer blocks for pallets in trailers; use 9-11 loading of pallets in marine containers, being sure to use spacer blocks in units with flat walls (Figure 38).

- *Pallet bins or cubes* — Loose horseradish roots may be packed in pallet bins or formed into a cube built up from a waxed fiberboard tray on a pallet and secured by completely enclosing the vertical sides of the cube with stretch-wrap film. Bin loading patterns are the same as for pallets (Figure 38). Take care not to block ventilation between the layers when stacking solid wall fiberboard bins or stretch-wrapped cubes.

## Jackfruit

### ***Recommended transport conditions:***

- *Desired transit temperature:*  
55°F (13°C)
- *Desired relative humidity:*  
85 to 95 percent
- *Highest freezing point:*  
unknown

Jackfruit is a tropical fruit that is extremely temperature sensitive; lower than desired temperatures will cause chilling injury, and higher than desired temperatures will cause rapid ripening. Jackfruit are quite perishable, with a shelf life of only 2 to 4 weeks at the optimum temperature of 55°F (13°C) for fruit that are greenish yellow maturity. Chilling injury results in dark-brown discoloration of the skin, pulp browning, off-flavor, and increased susceptibility to decay. Proper air circulation during transport is required to maintain uniform temperatures throughout the load, since fluctuating temperatures are detrimental. Ethylene is produced by jackfruit and will cause premature ripening. Provide a fresh air vent at minimum to prevent ethylene gas buildup inside the container or trailer or use an ethylene scrubber. Also, do not ship jackfruit with other produce that is not temperature compatible or that is sensitive to ethylene or produces high amounts of ethylene.

### ***Recommended loading methods:***

- *Fiberboard cartons* — Most jackfruit are packed in full telescoping fiberboard cartons and the fruit are wrapped, padded or packed in excelsior (softwood shavings) to prevent bruising. The cartons are usually palletized and secured by glue, straps, or plastic netting. Use

airflow or center loading with spacer blocks for pallets in trailers; block stow individual cartons or crates and use 9-11 loading of pallets in marine containers, being sure to use spacer blocks in units with flat walls (Figure 38). If not palletized, block stow the cartons crosswise or lengthwise and stack tightly together to get a dense load. In extremely cold weather, transfer the cartons onto floor racks or pallets in vehicles without deep T-rail floors so as to prevent freezing or chilling injury.

## Jicama

### ***Recommended transport conditions:***

- *Desired transit temperature:*  
55° to 65°F (13° to 18°C)
- *Desired relative humidity:*  
80 to 90 percent
- *Highest freezing point:*  
31.1°F (-0.5°C)
- *Do not top ice*

Jicama roots are susceptible to mechanical injuries during harvest and handling. Curing for 7 or more days at 68° to 77°F (20° to 25°C) and 95 to 100% RH will extend shelf life by reducing moisture loss. Jicamas can be shipped with ethylene-producing crops. If stored or transported below 55° to 59°F (13° to 15°C), chilling injury symptoms will develop (i.e., surface decay and discoloration). Maximum shelf life is 2 months, afterwards sprouting will cause water loss.

### ***Recommended loading methods:***

- *Fiberboard cartons* — Jicama is packed in loose-fill fiberboard cartons. The cartons are usually palletized and secured by glue, straps, or plastic netting. Use airflow or center loading with spacer blocks for pallets in trailers; block stow individual cartons and use 9-11 loading of pallets in marine containers, being sure to use spacer blocks in units with flat walls (Figure 38).

## Kale (see Greens)

## Hard Squash (see Squash and Pumpkins)

## Kiwifruit

### **Recommended transit conditions:**

- *Desired transit temperature:*  
32°F (0°C)
- *Desired relative humidity:*  
90 to 95 percent
- *Highest freezing point:*  
29.0°F (-1.7°C)

Cool kiwifruit to 32°F (0°C) as soon after harvest as possible using forced-air cooling, and maintain that temperature during transit. Kiwifruit are extremely sensitive to ethylene, which causes rapid softening and premature ripening of the fruit. Take care to prevent kiwifruit from being exposed to ethylene gas. Use electric forklifts to handle kiwifruit, since they do not produce ethylene as propane-fueled forklifts do. During transit, provide a fresh air vent at minimum to prevent ethylene gas buildup inside the container or trailer or use an ethylene scrubber. Do not ship kiwifruit in mixed loads with products that generate ethylene, such as apples and other tree fruit. Ripening kiwis also produce ethylene.

### **Recommended loading methods:**

- *Fiberboard trays and cartons* — Kiwifruit are shipped in fiberboard trays and cartons, often with plastic film liners. The trays and cartons are usually palletized and secured with vertical and horizontal bands or plastic netting. Use airflow or center loading with spacer blocks for pallets in trailers; use 9-11 loading of pallets in marine containers, being sure to use spacer blocks in units with flat walls (Figure 38).

## **Leafy greens (arugula, endive, escarole, spinach, watercress)**

### **Recommended transport conditions:**

- *Desired transit temperature:*  
32°F (0°C)
- *Desired relative humidity:*  
95 to 100 percent
- *Highest freezing point:*  
30°F (-1.1°C)
- *Package ice desirable; top ice is OK*

Leafy greens keep well at 32°F (0°C) in combination with high humidity. They have a high respiration rate and field heat must be quickly removed to maintain crispness and to retard spoilage. These crops are usually hydrocooled, vacuum-cooled or package iced. Leafy greens may be bunched or packed loose in waxed, fiberboard cartons or wooden crates. These products are delicate and must be handled carefully to prevent damage to the stems and leaves, which can lead to disease. They are usually ordered in small lots and shipped in mixed loads with other commodities. These crops are very sensitive to ethylene, so do not ship with ethylene-producing crops.

***Recommended loading methods:***

- *Waxed, fiberboard cartons and wirebound crates* — Leafy greens may be bunched or heads packed loose as appropriate in waxed, fiberboard cartons or wooden crates. Leafy greens are often packed in flexible or rigid plastic consumer packs, and then in fiberboard cartons. The packages are usually palletized and secured by glue, straps, or plastic netting. Use airflow or center loading with spacer blocks for pallets in trailers; block stow individual cartons or crates and use 9-11 loading of pallets in marine containers, being sure to use spacer blocks in units with flat walls (Figure 38). If package ice or top ice is used, the cartons must be moisture-resistant, and floor drains should be open so that meltwater will not accumulate on the vehicle floor.

**Leeks (see Onions, green)**

**Lemons**

***Recommended transport conditions:***

- *Desired transit temperature:*  
45° to 55°F (7° to 13°C)
- *Desired relative humidity:*  
85 to 95 percent
- *Highest freezing point:*  
29.4°F (-1.4°C)

Lemons are usually picked green and stored at around 14°C (58°F) until the peel turns yellow, up to several months. Lemons are subject to chilling injury, which causes peel pitting and physiological breakdown, if stored for long periods at temperatures below 58°F (14°C). Yellow lemons out of storage and lemons picked yellow have a shelf life of only 2 to 4 weeks. During domestic transit periods of several days, rot and mold are more likely to damage yellow lemons than cold. For transit and storage periods up to 4

weeks, yellow lemons may be held at any convenient temperature between 45° and 55°F (7° to 13°C) without incurring chilling injury. Lemons usually are shipped from cold storage and are near the desired transit temperature when loaded. They may be ventilated if outside temperatures fall within the desired temperature range.

Citrus fruits absorb odors quite readily and should not be shipped in mixed loads with any strongly scented vegetable, or vehicles harboring strong odors in general. In particular, citrus should not be shipped in mixed loads with onions, from which citrus fruit are known to absorb odors.

***Recommended loading methods:***

- *Fiberboard cartons* — Lemons may be packed in loose-fill or bag-master fiberboard cartons. The cartons are usually palletized and secured by glue, straps, or plastic netting. Use airflow or center loading with spacer blocks for pallets in trailers; block stow individual cartons and use 9-11 loading of pallets in marine containers, being sure to use spacer blocks in units with flat walls (Figure 38).

**Lettuce (head)**

***Recommended transport conditions:***

- *Desired transit temperature:*  
32°F (0°C)
- *Desired relative humidity:*  
98 to 100 percent
- *Highest freezing point:*  
31.7°F (-0.2°C)
- *Do not top ice*

Lettuce is one of the most perishable and easily damaged of all commercial vegetables. Heads of lettuce usually are field-packed directly into the shipping carton. The cartons are palletized, and the lettuce is quickly hydro-vacuum-cooled, then either moved to a cold room or immediately loaded onto a refrigerated trailer. Lettuce cannot be adequately cooled in transit; therefore take several pulp temperatures during loading to make sure that the lettuce is near the desired transport temperature. Lettuce is very sensitive to ethylene gas, so do not store or transport it with ethylene-producing commodities.

**Recommended loading methods:**

- *Waxed, fiberboard cartons* — Individual lettuce heads, either unwrapped or overwrapped in plastic film, are place-packed into waxed, fiberboard cartons. The cartons are usually palletized and secured by glue, straps, or plastic netting. Do not top ice lettuce. Use airflow or center loading with spacer blocks for pallets in trailers; block stow individual cartons and use 9-11 loading of pallets in marine containers, being sure to use spacer blocks in units with flat walls (Figure 38).

**Lettuce (leaf)**

**Recommended transport conditions:**

- *Desired transit temperature:*  
32°F (0°C)
- *Desired relative humidity:*  
98 to 100 percent
- *Highest freezing point:*  
31.7°F (-0.2°C)
- *Do not top ice*

All varieties of leaf lettuce (Bibb, Boston, Butter, Romaine, etc.) are very perishable and easily damaged. It is typically field-packed directly into the shipping carton. At higher ambient temperatures, the respiration rate is high, and bruised areas will decay rapidly; bacterial soft rot is the most serious lettuce disease. Leaf lettuce should be cooled immediately after harvest by either vacuum or hydrocooling. Once cooled, store and ship as near to 32°F (0°C) as possible and at high relative humidity. Leaf lettuce is very sensitive to ethylene gas, so do not store or transport it with ethylene-producing commodities.

**Recommended loading methods:**

- *Waxed fiberboard cartons and wirebound crates* — There are many kinds and sizes of fiberboard cartons used for shipping leaf lettuce. However, most shippers pack 12 or 24 bunches per carton or crate, either unwrapped or overwrapped in plastic film. The cartons and crates are usually palletized and secured by glue, straps, or plastic netting. Do not top ice lettuce. Use airflow or center loading with spacer blocks for pallets in trailers; block stow individual cartons and use 9-11 loading of pallets in marine containers, being sure to use spacer blocks in units with flat walls (Figure 38).

## Lettuce (Romaine)

### **Recommended transport conditions:**

- *Desired transit temperature:*  
32°F (0°C)
- *Desired relative humidity:*  
98 to 100 percent
- *Highest freezing point:*  
31.7°F (-0.2°C)
- *Do not top ice*

Romaine lettuce is a highly perishable crop that requires rapid cooling soon after harvest and maximum refrigeration during transit. It is typically field-packed directly into the shipping carton. Romaine lettuce should be cooled immediately after harvest by either vacuum or hydrocooling. Once cooled, store and ship as near to 32°F (0°C) as possible and at high relative humidity. Romaine lettuce is very sensitive to ethylene gas, so do not store or transport it with ethylene-producing commodities.

### **Recommended loading methods:**

- *Waxed fiberboard cartons* — Individual Romaine lettuce heads, either unwrapped or overwrapped in plastic film and bags, are place-packed into waxed, fiberboard cartons. The cartons are usually palletized and secured by glue, straps, or plastic netting. Do not top ice lettuce. Use airflow or center loading with spacer blocks for pallets in trailers; block stow individual cartons and use 9-11 loading of pallets in marine containers, being sure to use spacer blocks in units with flat walls (Figure 38).

## Limes

### **Recommended transport conditions:**

- *Desired transit temperature:*  
48° to 50°F (9° to 10°C)
- *Desired relative humidity:*  
85 to 95 percent
- *Highest freezing point:*  
29.1°F (-1.6°C)

Limes are picked green and should remain green during marketing for best quality. (Key limes are a different crop and are preferred with yellow color.) After harvest, limes are sorted, packed and room-cooled to around 50°F (10°C) and have a shelf life of 6 to 8 weeks. Limes are subject to attack by blue- and green-mold and stem-end rot. Limes picked when over-mature may develop styler-end (i.e., opposite the stem-end) breakdown during transit. Green color is maintained better at lower temperatures, but pitting (chilling injury) may occur when limes are held at temperatures below 46°F (8°C). Ethylene exposure can cause limes to lose their green color, revealing yellow patches that render the fruit unmarketable. Thus, limes should not be stored or transported with ethylene-producing fruit and care should be taken to avoid other sources of ethylene such as vehicle exhaust. Ethylene scrubbing can be beneficial in preventing de-greening and slowing decay development.

Citrus fruits absorb odors quite readily and should not be shipped in mixed loads with any strongly scented vegetable, or vehicles harboring strong odors in general. In particular, citrus should not be shipped in mixed loads with onions, from which citrus fruit are known to absorb odors.

***Recommended loading methods:***

- *Fiberboard cartons* — Limes may be packed in loose-fill or bag-master fiberboard cartons. The cartons are usually palletized and secured by glue, straps, or plastic netting. Use airflow or center loading with spacer blocks for pallets in trailers; block stow individual cartons and use 9-11 loading of pallets in marine containers, being sure to use spacer blocks in units with flat walls (Figure 38).

**Lima beans (see Beans)**

**Litchi, Lychee**

***Recommended transport conditions:***

- *Desired transit temperature:*  
36° to 41°F (2° to 5°C)
- *Desired relative humidity*  
90 to 95 percent
- *Highest freezing point:*  
30.4°F (-0.9°C) estimated

Litchi fruit should be completely red, as they do not continue ripening after harvest. Litchis should be cooled using forced-air cooling or hydrocooling



because they are fairly perishable, with a shelf life of only 3 to 5 weeks at the optimum temperature of 36°F (2°C). Surface browning detracts from litchi value since it indicates that the fruit have been injured or handled at higher temperatures with lower humidity. Ethylene exposure accelerates litchi flesh breakdown and favors decay development. Imported litchis may be treated with SO<sub>2</sub> gas, like grapes, followed by dipping in hydrochloric acid to preserve the red color, but the treatment is not approved for litchis marketed in the U.S.

***Recommended loading methods:***

- *Fiberboard cartons* — Litchis are shipped in loose-filled fiberboard cartons, often with plastic film liners. The cartons are secured to pallets with vertical and horizontal bands or plastic netting. Use airflow or center loading with spacer blocks for pallets in trailers; block stow individual cartons and use 9-11 loading of pallets in marine containers, being sure to use spacer blocks in units with flat walls (Figure 38).

## Longan

***Recommended transport conditions:***

- *Desired transit temperature:*  
40° to 45°F (4° to 7°C)
- *Desired relative humidity*  
90 to 95 percent
- *Highest freezing point:*  
30.4°F (-0.9°C) estimated

Longan fruit should be fully ripe when harvested, as they do not continue ripening after harvest. Ripeness is indicated by yellowish brown to light brown appearance. Longans should be cooled using forced-air cooling because they are quite perishable, with a shelf life of only 2 to 4 weeks at the optimum temperature of 40°F (4°C). At higher temperature and lower humidity, the fruit surface becomes dull, dark brown, the flesh becomes watery, and decay is prevalent. Lower temperatures cause chilling injury, resulting in off-flavor and dull, dark brown peel. Imported longans may be treated with SO<sub>2</sub> gas, like grapes, to inhibit peel browning and decay, but the treatment is not approved for longans marketed in the U.S.

***Recommended loading methods:***

- *Fiberboard cartons* — Longans are shipped in fiberboard cartons, often with plastic film liners. The cartons may be loose-filled or bunches of longans may be place-packed into the cartons. The cartons are

palletized and secured with vertical and horizontal bands or plastic netting. Use airflow or center loading with spacer blocks for pallets in trailers; block stow individual cartons and use 9-11 loading of pallets in marine containers, being sure to use spacer blocks in units with flat walls (Figure 38).

## **Mandarins**

### ***Recommended transport conditions:***

- *Desired transit temperature:*  
40°F (4°C)
- *Desired relative humidity*  
90 to 95 percent
- *Highest freezing point:*  
30.1°F (-1.1°C)

Mandarins (also called clementines, tangerines or satsumas) are highly perishable fruit. During marketing they are very susceptible to decay, particularly green- and blue-mold rots. Careful handling from tree to table helps to prevent bruising and skin breaks that provide ready entrance for decay organisms. Other citrus varieties, such as tangelos and honey tangerines (Murcott), are thin-skinned and need careful handling. Mandarins can develop chilling injury below at 40° to 46°F (4° to 8°C), but this is highly dependent on duration of exposure to the low temperature, variety, and maturity. Chilling injury causes pitting and brown discoloration of the peel and increased susceptibility to decay. Some mandarins may be given a cold treatment of as low as 32°F (0°C) during transport for insect quarantine purposes, but the tolerance is dependent not only on variety and maturity, but also growing region. Precool mandarins before shipping.

Citrus fruits absorb odors quite readily and should not be shipped in mixed loads with any strongly scented vegetable, or vehicles harboring strong odors in general. In particular, citrus should not be shipped in mixed loads with onions, from which citrus fruit are known to absorb odors.

### ***Recommended loading methods:***

- *Fiberboard cartons* — Mandarins may be packed in loose-fill or bag-master fiberboard cartons. The cartons are usually palletized and secured by glue, straps, or plastic netting. Use airflow or center loading with spacer blocks for pallets in trailers; block stow individual cartons and use 9-11 loading of pallets in marine containers, being sure to use spacer blocks in units with flat walls (Figure 38).

## Mangoes

### **Recommended transport conditions:**

- *Desired transit temperature:*  
55°F (13°C)
- *Desired relative humidity:*  
85 to 90 percent
- *Highest freezing point:*  
30.4°F (-0.9°C)

Generally, the best transit temperature for mangoes is 55°F (13°C). Although mangoes ripen slowly at 55°F (13°C), at lower temperatures the fruit are highly susceptible to chilling injury, which is manifested as lack of aroma, lenticel discoloration, gray scald-like discoloration of the skin, pitting, uneven ripening, and poor flavor and color development. While most mango varieties are susceptible to chilling injury below 55°F (13°C), Tommy Atkins can withstand transit temperatures down to 50°F (10°C) before sustaining chilling injury, while Ataulfo (Honey) can be damaged at temperatures above 55°F (13°C), depending on the duration of exposure.

### **Recommended loading methods:**

- *Fiberboard cartons* — Mangoes are packed in 10-lb (4.5-kg) fiberboard cartons, which are palletized and secured by glue, straps, or plastic netting. Use airflow or center loading with spacer blocks for pallets in trailers; block stow individual cartons and use 9-11 loading of pallets in marine containers, being sure to use spacer blocks in units with flat walls (Figure 38).

## Mangosteens

- *Desired transit temperature:*  
54° to 57°F (12° to 14°C)
- *Desired relative humidity*  
85 to 95 percent
- *Highest freezing point:*  
30.4°F (-0.9°C) estimated

Mangosteen fruit are reddish-purple to dark purple when ripe. The fruit are typically room-cooled to around 54° to 57°F (12° to 14°C) and have a shelf life of 2 to 4 weeks. The fruit are highly susceptible to chilling injury, which results in hardening of the peel and increased decay.

**Recommended loading methods:**

- *Fiberboard cartons* — Mangosteens are packed in loose-filled fiberboard cartons. The cartons are usually palletized and secured by glue, straps, or plastic netting. Use airflow or center loading with spacer blocks for pallets in trailers; block stow individual cartons and use 9-11 loading of pallets in marine containers, being sure to use spacer blocks in units with flat walls (Figure 38).

**Melons (Honeydew, Canary, Casaba, Crenshaw, Persian)  
(for Muskmelon, see Cantaloupes; for Watermelons, see that section)**

**Recommended transport conditions:**

- *Desired transit temperature:*  
45° to 50°F (7° to 10°C)
- *Desired relative humidity:*  
90 to 95 percent
- *Highest freezing point:*  
30.5°F (-0.8°C)
- *Do not top ice*

Casaba, Crenshaw, Honeydew and Persian melons are easily bruised and are very sensitive to chilling injury (pitting and physiological breakdown). Shipping at temperatures below 45°F (7°C) may result in sunken areas on the skin and eventual decay. These melons may be pre-ripened, which reduces chilling sensitivity. Ripening treatment involves exposure to 100 ppm ethylene gas immediately after harvest for 24 hours at 55°F (12.5°C) to 77°F (25°C). Following ethylene treatment, the melons must be immediately cooled to recommended temperatures to slow ripening during shipping. Hydrocooling and forced-air cooling are the most common cooling methods.

**Recommended loading methods:**

- *Fiberboard cartons* — Most melons are packed in loose-filled fiberboard cartons, which are usually palletized and secured by glue, straps, or plastic netting. Use airflow or center loading with spacer blocks for pallets in trailers; block stow individual cartons and use 9-11 loading of pallets in marine containers, being sure to use spacer blocks in units with flat walls (Figure 38).

## Mushrooms

### **Recommended transport conditions:**

- *Desired transit temperature:*  
32°F (0°C)
- *Desired relative humidity:*  
95 percent
- *Highest freezing point:*  
30.4°F (-0.9°C)
- *Do not top ice*

Fresh mushrooms are highly perishable, with a shelf life of about 1 week under optimum conditions. Prompt cooling after harvest, preferably using forced-air cooling, and close temperature control during transit are essential. Mushrooms are easily bruised and should be handled carefully. Mushrooms are sensitive to water and may develop brown spots and decay rapidly, therefore moisture from condensation or other sources must be avoided. Fresh mushrooms may be prepackaged in hinged, vented ‘clamshell’ packages, which are then packed in fiberboard master cartons. They also may be packed in bulk in larger fiberboard cartons prior to palletizing. Mushrooms should not be shipped in mixed loads with green onions, from which mushrooms absorb odors.

### **Recommended loading methods:**

- *Fiberboard cartons* — Mushrooms are typically packed in consumer packages within fiberboard flats or multi-layer cartons stacked on pallets. Use airflow or center loading with spacer blocks for pallets in trailers, being sure to use spacer blocks in units with flat walls to avoid heat transfer across the walls (Figure 38).

## Muskmelon (see Cantaloupes)

## Nectarines (see Peaches and Nectarines)

## Okra

### **Recommended transport conditions:**

- *Desired transit temperature:*  
45° to 50°F (7° to 10°C)
- *Desired relative humidity:*  
90 to 95 percent

- *Highest freezing point:*  
28.7°F (-1.8°C)
- *Do not top ice*

Okra has a very high respiration rate and deteriorates rapidly and at warm temperatures. Under best conditions okra has a shelf life of about 10 days. Prompt cooling after harvest, preferably using forced-air cooling, and close temperature control during transit are essential. Avoid contact with water, which will cause spotting at all temperatures. Okra is susceptible to chilling injury at temperatures below 45°F (7°C), which is manifested by surface discoloration, pitting, and decay. Okra also is easily bruised, and bruised or abraded areas will blacken rapidly.

***Recommended loading methods:***

- *Fiberboard cartons and wirebound crates* — Okra is packed in loose-filled cartons or crates, which are usually palletized and secured by glue, straps, or plastic netting. Use airflow or center loading with spacer blocks for pallets in trailers; block stow individual cartons and use 9-11 loading of pallets in marine containers, being sure to use spacer blocks in units with flat walls (Figure 38).

**Onions (green), Shallots (green), and Leeks**

***Recommended transport conditions:***

- *Desired transit temperature:*  
32°F (0°C)
- *Desired relative humidity:*  
95 to 100 percent
- *Highest freezing point:*  
Green onions (bunch or spring): 30.4°F (-0.9°C)  
Shallots (white leaf bare): 31.6°F (-0.2°C)  
Leeks (blanched stalk): 30.7°F (-0.7°C)
- *May be package-iced or top iced*

Green onions and green shallots are highly perishable and should be cooled soon after harvest. Package ice or hydrocooling cools quickly and helps to retain moisture and crispness while reducing yellowing during shipping. See “Ice” under “Refrigeration Methods” in section I for further information about icing. It is essential that high humidity be maintained for these products to avoid wilting. Do not load green onions with figs, grapes, mushrooms, rhubarb, or sweet corn, since these products will absorb the green onion

odor. Leeks' odor is also absorbed by figs and grapes. Under optimum conditions, the potential shelf life of green onions and shallots is about 1 month, and leeks 3 months.

***Recommended loading methods:***

- *Fiberboard cartons (waxed)* — These products are bunched and packed into waxed fiberboard cartons, sometimes with layers of ice between layers of naked product, or as an 'iceless' pack in consumer-size plastic bags. If package ice or top ice is used, the cartons must be moisture-resistant, and floor drains should be open so that meltwater will not accumulate on the vehicle floor. The cartons are usually palletized and secured by glue, straps, or plastic netting. Use airflow or center loading with spacer blocks for pallets in trailers; block stow individual cartons and use 9-11 loading of pallets in marine containers, being sure to use spacer blocks in units with flat walls (Figure 38).

**Onions (dry bulbs)**

***Recommended transport conditions:***

- *Desired transit temperature:*  
dried (cured), storage varieties: 32° to 45°F (0° to 7°C)  
undried (uncured), fresh varieties: 45° to 60°F (7° to 15.5°C)
- *Desired relative humidity:*  
65 to 70 percent
- *Highest freezing point:*  
30.6°F (-0.8°C)
- *Do not top ice*

Dry onions store well if held at the proper temperature and humidity and kept dry after they are dried. Higher temperatures will cause sprouting and decay. Condensation (sweating) will occur on onions removed from cold storage during warm weather upon contact with warm humid air. Avoid these conditions by avoiding holding or loading from an open dock. Condensation can also be avoided by precooling the trailer before loading and maintaining adequate air circulation during transit.

Onions should not be shipped in mixed loads of commodities that include apples or pears, from which onions absorb odors. Also, apples, pears, celery, and citrus absorb odors from onions.

Dry onions are bulk packaged in a variety of ways for shipment, including 25- and 50-pound (11.3 and 22.7 kg) mesh or plastic bags, 40-pound (18 kg)

fiberboard cartons, bulk bins, and various sizes of consumer-size mesh and plastic bags packed in shipping cartons.

***Recommended loading methods:***

- *Open mesh or plastic bags* — Stack the bags lengthwise or crosswise on pallets and wrap with net or strap to secure the onions to the pallet. Use airflow or center loading with spacer blocks for pallets in trailers; use 9-11 loading of pallets in marine containers, being sure to use spacer blocks in units with flat walls (Figure 38). Sacks or bags of onions may be shipped in railcars with no specific loading pattern, but it is not a recommended practice.
- *Fiberboard cartons* — Onions packed in loose-filled cartons are usually palletized and secured by glue, straps, or plastic netting. Use airflow or center loading with spacer blocks for pallets in trailers; block stow individual cartons and use 9-11 loading of pallets in marine containers, being sure to use spacer blocks in units with flat walls (Figure 38).
- *Pallet bins* — Onions are shipped in bulk bins for processing. Do not overfill the bins to avoid crushing the onions in the bottom bin. Bin loading patterns are the same as for pallets (Figure 38). Take care not to block ventilation between the layers when stacking solid wall fiberboard bins.

**Oranges**

***Recommended transport conditions:***

- *Desired transit temperature:*
  - Florida and Texas: 32° to 34°F (0° to 1°C)
  - California and Arizona: 38° to 48°F (3° to 9°C)
- *Desired relative humidity:*
  - 85 to 90 percent
- *Highest freezing point:*
  - Peel: 29.7°F (-1.3°C)
  - Flesh: 30.6°F (-0.8°C)

The pre-shipment handling of oranges varies by production area and season. Generally, the fruit is washed, waxed, treated, and packaged for shipment. Some shippers do not precool oranges; in those cases, the fruit temperature at loading depends on ambient temperature. When precooled, oranges are usually room cooled to the desired transit temperature. It is important to precool oranges that are prepackaged in polyethylene or mesh consumer



bags and shipped in master shipping cartons, since the packaging impedes heat removal during storage and transport.

California and Arizona Navel oranges shipped below 38°F (3°C) and Arizona Valencia oranges shipped below 48°F (9°C) are susceptible to chilling injury. Symptoms are peel pitting, brown stains, and increased decay. Oranges from all citrus-producing areas are subject to blue mold and green mold rots. In addition, Florida and Texas fruit are susceptible to stem-end rot. Losses from decay can be reduced by decay inhibitors, careful handling to prevent skin breaks, and proper refrigeration.

Citrus fruits absorb odors quite readily and should not be shipped in mixed loads with any strongly scented vegetable, or vehicles harboring strong odors in general. In particular, citrus should not be shipped in mixed loads with onions, from which citrus fruit are known to absorb odors.

### ***Recommended loading methods:***

- *Fiberboard cartons* — Oranges may be packed in loose-fill or bag-master fiberboard cartons. The cartons are usually palletized and secured by glue, straps, or plastic netting. Take care that proper precooling has been done when transporting oranges in bag masters. It is more difficult to manage the fruit temperature in transit when oranges are packed in polyethylene film or mesh bags and packed in cartons. Use airflow or center loading with spacer blocks for pallets in trailers; block stow individual cartons and use 9-11 loading of pallets in marine containers, being sure to use spacer blocks in units with flat walls (Figure 38).
- *Pallet bins* — Some shippers transport oranges in fiberboard or plastic pallet bins. The oranges may be in bulk (i.e., loose) or in open mesh bags when packed in the bins. Stack these bins two-high in the truck. Do not overfill the bins to avoid crushing the oranges in the bottom bin. Bin loading patterns are the same as for pallets (Figure 38). Take care not to block ventilation between the layers when stacking solid wall fiberboard bins.

## **Papaya**

### ***Recommended transport conditions:***

- *Desired transit temperature:*  
45° to 55°F (7° to 13°C)
- *Desired relative humidity:*  
90 to 95 percent

- *Highest freezing point:*  
30.4°F (-0.9°C)

There are two types of papayas: ‘Solo’ type fruit are smaller (10 to 25 oz; 300 to 700 g), while the larger ‘Maradol’ type varieties are much larger (3 to 6 lbs; 1.4 to 2.7 kg). Papayas can be marketed at several different ripeness stages: mature-green to ¼ yellow, ¼ to ½ yellow, or ½ to ¾ yellow. Papayas are usually forced-air cooled to the desired transport temperature to delay further ripening. Mature-green fruit can be ripened using ethylene gas at 70° to 81°F (21° to 27°C). Although papayas are able to ripen after harvest, the initial quality does not improve because the fruit do not become sweeter while ripening off the tree.

Papayas are chilling sensitive and their susceptibility to chilling injury declines as the fruit ripen. Thus, mature-green to ¼ yellow papayas should be stored and transported at 55°F (13°C), ¼ to ½ yellow papayas at 50°F (10°C), and ½ to ¾ yellow papayas at 45°F (7°C) for best quality. Symptoms of chilling injury include surface pitting, blotchy coloration, uneven ripening, skin scald, hard core (hard areas in the flesh around the vascular bundles), watersoaking of the flesh, and increased decay. Potential shelf life at non-chilling temperatures varies from 1 to 3 weeks for papayas at different ripeness stages.

***Recommended loading methods:***

- *Fiberboard cartons* — Because papayas are very sensitive to bruising, cuts, and abrasions, they are packed in single layer fiberboard cartons with foam mesh sleeves around individual fruit and a foam pad placed beneath the fruit. The cartons are usually palletized and secured by glue, straps, or plastic netting. Use airflow or center loading with spacer blocks for pallets in trailers; block stow individual cartons and use 9-11 loading of pallets in marine containers, being sure to use spacer blocks in units with flat walls (Figure 38).

**Parsley (see Herbs)**

**Parsnips**

***Recommended transport conditions:***

- *Desired transit temperature:*  
32°F (0°C)
- *Desired relative humidity:*  
98 to 100 percent

- *Highest freezing point:*  
30.4°F (-0.9°C)
- *May be package-iced or top iced*

Parsnips are handled with the tops removed. Parsnips are very sensitive to water loss, so it is essential to keep the humidity very high. Cool parsnips after harvest using hydrocooling or package icing; parsnips can be top iced to help retain moisture and reduce shriveling. See “Ice” under “Refrigeration Methods” in section I for further information about icing. Do not ship parsnips with ethylene-producing commodities, because this will cause the roots to develop a bitter flavor. Under proper conditions, parsnips will keep for 4 to 6 months.

### ***Recommended loading methods:***

- *Waxed fiberboard cartons* — Parsnips are usually packed horizontally in fiberboard cartons that are waxed or have plastic carton liners. The cartons are usually palletized and secured by glue, straps, or plastic netting. Use airflow or center loading with spacer blocks for pallets in trailers; block stow individual cartons and use 9-11 loading of pallets in marine containers, being sure to use spacer blocks in units with flat walls (Figure 38). If top ice is used, the cartons must be moisture-resistant, and floor drains should be open so that meltwater will not accumulate on the vehicle floor.
- *Open mesh or plastic film bags* — Parsnips in bags usually are stacked so that, when loaded, the roots are in a vertical position. Wrap palletized loads with net, or strap for stability. Use airflow or center loading with spacer blocks for pallets in trailers; use 9-11 loading of pallets in marine containers, being sure to use spacer blocks in units with flat walls (Figure 38). If top ice is used, the cartons must be moisture-resistant, and floor drains should be open so that meltwater will not accumulate on the vehicle floor.

## **Passionfruit**

- *Desired transit temperature:*  
41° to 50°F (5° to 10°C)
- *Desired relative humidity:*  
90 to 95 percent
- *Highest freezing point:*  
30.4°F (-0.9°C) estimated

Passionfruit may be either yellow or purple when ripe. The fruit are typically forced-air cooled to around 45°F (7°C). The fruit are susceptible to chilling injury, which results in surface pitting, external and internal discoloration, watersoaking, impaired ripening, and increased decay. Partially ripe fruit have a shelf life of 3 to 5 weeks at 45° to 50°F (7° to 10°C) and fully ripe fruit have a shelf life of about 1 week at 41° to 45°F (5° to 7°C).

***Recommended loading methods:***

- *Fiberboard cartons* — Passionfruit are packed in a single layer in fiberboard cartons (‘flats’) with plastic trays that have cells to hold individual fruit. The cartons are usually palletized and secured by glue, straps, or plastic netting. Use airflow or center loading with spacer blocks for pallets in trailers; use 9-11 loading of pallets in marine containers, being sure to use spacer blocks in units with flat walls (Figure 38).

**Peaches and Nectarines**

***Recommended transport conditions:***

- *Desired transit temperature:*  
31° to 32°F (-0.6° to 0°C)
- *Desired relative humidity:*  
90 to 95 percent
- *Highest freezing point:*  
30.4°F (-0.9°C)

The traditional melting flesh fresh market types of peaches and nectarines (mostly freestone) are relatively tender fruit that bruise easily. Non-melting flesh types (usually clingstone) are much firmer and have traditionally been used for processing, but new non-melting varieties are increasingly being developed for the fresh market. Peaches and nectarines are usually harvested and shipped while still firm, so that physical injury will be minimized during packing, transit and marketing. Some peaches and nectarines are picked ‘tree ripe’ and handled more carefully. To delay ripening and retard decay, promptly hydrocool or forced-air cool peaches and nectarines to 32°F (0°C) before loading. Shelf life varies widely among varieties, from 1 to 6 weeks.

Peaches and nectarines are subject to chilling injury (‘internal breakdown’), but are most sensitive within the range of 36° to 50°F (2° to 10°C). Symptoms of chilling injury are lack of aroma, flesh that is discolored, dry and mealy or leathery, and inhibition of ripening. Chilling sensitivity declines as the fruit ripens. To reduce chilling sensitivity, peaches and nectarines may be

picked when firm enough to avoid bruising, packed, then ‘conditioned’ (i.e., partially ripened) at 70° to 75°F (21° to 24°C) for 1 to 3 days before being cooled to near the desired storage or transit temperature of 32°F (0°C).

***Recommended loading methods:***

- *Fiberboard cartons* — Most peaches are packed in volume-filled cartons. Tree-ripe fruit are packed in plastic trays with cells for individual fruit, in either one or two layers, which are then packed in the cartons. The cartons are usually palletized and secured by glue, straps, or netting. Use airflow or center loading with spacer blocks for pallets in trailers; block stow individual cartons and use 9-11 loading of pallets in marine containers, being sure to use spacer blocks in units with flat walls (Figure 38).

**Pears**

***Recommended transport conditions:***

- *Desired transit temperature:*  
32°F (0°C)
- *Desired relative humidity:*  
90 to 95 percent
- *Highest freezing point:*  
29.2°F (-1.6°C)

Precool pears as soon after harvest as possible to protect their shelf life. A storage period of 1 month at 32°F (0°C) may be required for pears to ripen properly. The storage life of pears ranges from 2 to 8 months, depending on variety. Warming of pears after cold storage starts the ripening process, which cannot be reversed. Therefore, transport pears as close to the storage temperature as possible.

Pears absorb odors quite readily and should generally not be shipped in vehicles harboring strong odors. Pears should not be shipped in mixed loads of commodities that include onions or potatoes, from which pears absorb odors. Also, cabbage, carrots, celery, figs, onions, and potatoes absorb odors from pears. Pears also produce ethylene, and they should not be shipped with products sensitive to this gas.

***Recommended loading methods:***

- *Fiberboard cartons* — Fiberboard cartons of pears may be volume-filled, place-packed, or tight-filled (vibration settled) with the cover tightly secured with strapping material or staples. Tight-fill packing reduces

fruit bouncing and rotation in the cartons from highway vibration. Fruit movement within the cartons results in discolored rings in the skin around individual fruit, known as ‘roller bruising.’ The cartons are usually palletized and secured by glue, straps, or netting. Use airflow or center loading with spacer blocks for pallets in trailers; block stow individual cartons and use 9-11 loading of pallets in marine containers, being sure to use spacer blocks in units with flat walls (Figure 38).

## **Peas (green and snow peas in pods)**

### ***Recommended transport conditions:***

- *Desired transport temperature:*  
32°F (0°C)
- *Desired relative humidity:*  
95 to 98 percent
- *Highest freezing point:*  
Pods: 30.9°F (-0.6°C)  
Shelled peas: 29.9°F (-1.2°C)
- *May be package-iced or top iced*

Fresh green peas are extremely perishable and require the utmost care to keep them in salable condition. To slow the changing of sugar to starch, lower and hold the temperature of the peas to near 32°F (0°C) immediately after harvest by vacuum- or hydrocooling. Top-ice after loading to help maintain a low temperature and the fresh appearance of the pods. With less-than-truckload shipments of peas and where top-icing is not feasible, pack the peas with crushed ice. See “Ice” under “Refrigeration Methods” in section I for further information about icing. Peas are ethylene- sensitive, so do not ship in mixed loads with ethylene-producing products.

### ***Recommended loading methods:***

- *Waxed, fiberboard cartons and wirebound crates* — Packages for green peas are loose-filled, sometime with package ice. Pack peas in waxed fiberboard cartons that are well ventilated, with holes on all faces. The cartons and crates are usually palletized and secured by glue, straps, or netting. Use airflow or center loading with spacer blocks for pallets in trailers; block stow individual cartons and use 9-11 loading of pallets in marine containers, being sure to use spacer blocks in units with flat walls (Figure 38). When package ice or top ice is used, the cartons must be moisture-resistant, and floor drains should be open so that meltwater will not accumulate on the vehicle floor.

## Peppers (sweet; pungent)

### ***Recommended transport conditions:***

- *Desired transit temperature:*  
45° to 55°F (7° to 13°C)
- *Desired relative humidity:*  
90 to 95 percent
- *Highest freezing point:*  
30.7°F (-0.7°C)

Mature-green peppers held at temperatures below 45°F (7°C) will incur chilling injury. Peppers stored at chilling temperatures develop pitting, scald, and various decays. Ripe (colored) peppers are less sensitive to chilling injury. However, at temperatures above 55°F (13°C) both green and ripe peppers can decay quite rapidly. Peppers are sensitive to ethylene, which will hasten ripening and deterioration, so do not ship with ethylene-producing products.

### ***Recommended loading methods:***

- *Fiberboard cartons* — Sweet peppers are most commonly packed in loose-filled waxed, fiberboard cartons, but may also be placed in consumer trays or plastic bags that are then packed into unwaxed cartons. The cartons are usually palletized and secured by glue, straps, or netting. Use airflow or center loading with spacer blocks for pallets in trailers; block stow individual cartons and use 9-11 loading of pallets in marine containers, being sure to use spacer blocks in units with flat walls (Figure 38).

## Persimmons

### ***Recommended transport conditions:***

- *Desired transit temperature:*  
32°F (0°C)
- *Desired relative humidity:*  
90 to 95 percent
- *Highest freezing point:*  
28.1°F (-2.2°C)

Most persimmons are non-astringent types that can be eaten before they are fully ripe; the astringent types are inedible until they are completely ripe,

at which point the fruit are extremely soft. Persimmons should be yellow or orange to reddish-orange, not green, for best quality. Precool persimmons as soon after harvest as possible using forced-air cooling to protect their shelf life. The storage life of persimmons ranges from 2 to 4 months, depending on variety.

Persimmons are chilling sensitive, but are most sensitive within the range of 41° to 59°F (5° to 15°C). Symptoms of chilling injury are flesh browning and softening. Ethylene exposure aggravates chilling injury. Extensive warming of persimmons promotes ripening, which is difficult to reverse once initiated. Therefore, transport persimmons as close to the optimum storage temperature of 32°F (0°C) as possible.

***Recommended loading methods:***

- *Fiberboard cartons* — Persimmons are packed in a single layer in plastic-lined fiberboard cartons (“flats”) with plastic trays that have cells to hold individual fruit. The cartons are usually palletized and secured by glue, straps, or netting. Use airflow or center loading with spacer blocks for pallets in trailers; block stow individual cartons and use 9-11 loading of pallets in marine containers, being sure to use spacer blocks in units with flat walls (Figure 38).

## **Pineapples**

***Recommended transport conditions:***

- *Desired transit temperatures:*
  - Mature-green fruit: 50° to 55°F (10° to 13°C)
  - Ripe fruit: 45°F (7°C)
- *Desired relative humidity:*
  - 85 to 90 percent
- *Highest freezing point:*
  - 30.0°F (-1.1°C)

Pineapples are of best quality when allowed to ripen on the plant; fruit harvested mature-green or partially ripe can change color after harvest, but do not develop the best quality. Since pineapples are quite perishable, with only 2 to 4 weeks potential shelf life, the fruit should be cooled quickly after harvest to the desired transit temperature using forced-air cooling.

Mature-green pineapples are susceptible to chilling injury if exposed to temperatures below 50°F (10°C). Ripe fruit are less susceptible to chilling injury. Symptoms of chilling injury are impaired ripening, brown or dull shell



color beginning in the core, water-soaked flesh, wilting of the crown, green spotting, and failure to develop a good flavor. Chilled fruit is particularly subject to decay if not kept refrigerated.

Pineapples should not be shipped in mixed loads that include avocados or peppers, from which pineapples absorb odors.

***Recommended loading methods:***

- *Fiberboard cartons* — Cartons often have fiberboard inserts placed between individual fruit to prevent bruising during transit. This also helps prevent freezing or chilling injury from occurring. The cartons are usually palletized and secured by glue, straps, or netting. Use airflow or center loading with spacer blocks for pallets in trailers; block stow individual cartons and use 9-11 loading of pallets in marine containers, being sure to use spacer blocks in units with flat walls (Figure 38).

**Plums and Fresh Prunes (also, Apriplums, Apriums, Plumcots, and Pluots)**

***Recommended transport conditions:***

- *Desired transit temperature:*  
32°F (0°C)
- *Desired relative humidity:*  
90 to 95 percent
- *Highest freezing point:*  
30.5°F (-0.8°C)

Plums are subject to chilling injury ('internal breakdown'), but are most sensitive within the range of 36° to 46°F (2° to 8°C). Symptoms of chilling injury are lack of aroma, flesh translucency and browning, mealy flesh, flesh bleeding, and inhibition of ripening. Chilling sensitivity declines as the fruit ripen, so plums should be harvested when partially ripe but firm. They must be quickly precooled to near the desired storage and transit temperature of 32°F (0°C) using forced-air cooling for maximum shelf life, which varies among varieties from 1 to 8 weeks. Handle carefully, because bruising and skin breaks may result in decay and loss of quality. Plums and fresh prunes are ethylene producers and may be shipped with other similar tree fruit commodities.

***Recommended loading method:***

- *Fiberboard cartons* — Most plums are packed in volume-filled cartons. A considerable amount of this fruit is tight-filled (vibration-settled in the

cartons with the cover tightly fastened) to reduce fruit bouncing and rotation in the cartons from highway vibration. Fruit movement within the cartons results in discolored rings in the skin around individual fruit, known as 'roller bruising.' Fruit may also be packed in plastic 'clamshell' packages or in plastic trays with cells for individual fruit, in either one or two layers, which are then packed in the cartons. The cartons are usually palletized and secured by glue, straps, or netting. Use airflow or center loading with spacer blocks for pallets in trailers; block stow individual cartons and use 9-11 loading of pallets in marine containers, being sure to use spacer blocks in units with flat walls (Figure 38).

## **Pomegranates**

### ***Recommended transport conditions:***

- *Desired transit temperatures:*  
41° to 45°F (5° to 7°C)
- *Desired relative humidity:*  
90 to 95 percent
- *Highest freezing point:*  
27.6°F (-2.4°C)

Pomegranates must be fully ripe at harvest, as they do not ripen after harvest. The outer peel should be completely red. Pomegranates are quite susceptible to water loss, which results in shriveling of the peel. Pomegranates are somewhat chilling sensitive and should be held at 45°F (7°C) if storage and transport total longer than 2 months. Chilling injury symptoms are brown discoloration of the peel and internal (normally white) membranes and fading of the color of the arils (flesh surrounding the seeds).

### ***Recommended loading methods:***

- *Fiberboard cartons* — Pomegranates are packed in two layers in fiberboard cartons with plastic liners, either place-packed or packed in plastic trays that have cells to hold individual fruit. The cartons are usually palletized and secured by glue, straps, or netting. Use airflow or center loading with spacer blocks for pallets in trailers; block stow individual cartons and use 9-11 loading of pallets in marine containers, being sure to use spacer blocks in units with flat walls (Figure 38).

## Potatoes

### ***Recommended transport conditions:***

- *Desired transport temperature:*
  - Early crop — for table: 50° to 60°F (10° to 16°C)
  - Early crop — for chipping: 65° to 70°F (18° to 21°C)
  - Late crop — for table: 40° to 50°F (4° to 10°C)
  - Late crop — for chipping: 50° to 60°F (10° to 16°C)
- *Desired relative humidity:*
  - 90 percent
- *Highest freezing point:*
  - 30.9°F (-0.6°C)

Ventilation, heating, or cooling may be required for potatoes in transit depending on the time of year and outside temperature conditions.

**Early crop, or new, potatoes** are harvested and shipped from the southern states during the winter, spring, and summer months. Because these potatoes have thin skins, they are easily skinned and bruised. Broken skins can allow decay organisms to enter and cause tissue browning, lowering market value. Potatoes, fortunately, have the inherent ability to seal skin breaks by producing suberin and wound periderm, which are essentially new skin. This self-healing process proceeds best at a high humidity and temperatures of 60° to 70°F (16° to 21°C). If newly harvested potatoes are to be in transit for more than 48 hours, the lower portion of this temperature range is recommended. During cooler periods, early crop potatoes may be shipped satisfactorily under ventilation only. However, during later spring and summer, the load should be refrigerated.

**Late crop potatoes** are harvested during the summer and fall, mostly in the northern states. These varieties have longer growing time to mature before being dug and skins that are tougher and less sensitive to skinning during handling. They also can be wound-healed at lower temperatures and humidity than required by early crop potatoes. Late crop potatoes are shipped from storage in the late fall, winter, and early spring. Since many shipments move through areas with subfreezing temperatures, heat is often needed when transporting late crop potatoes. Operate fans with the heating system to circulate the warmed air around the load.

Potatoes are sensitive to bruising during handling. Studies have shown that potatoes incur the most loading-related bruising when dropped onto hard surfaces from drop heights exceeding 30 inches (76 cm).

**CAUTION:** Loading potatoes on wood pallets with the stringers running lengthwise provides a means of protecting the potatoes at floor level from freezing or overheating by allowing circulating air under the load. Ventilate loads of late crop potatoes when outside temperatures range between 40° to 50°F (4° to 10°C) by opening the vent doors. At temperatures below or above this range, only open vent doors slightly to avoid oxygen starvation of the load.

Chipping potatoes are subject to a disorder called ‘low temperature sweetening’. Shipping at temperatures below those recommended may cause adverse chemical reactions that increase the sugar content of the potatoes. This subsequently results in undesirable dark-colored chips. Conditions in the transport vehicle that allow carbon dioxide (CO<sub>2</sub>) build-up or oxygen (O<sub>2</sub>) depletion also may result in off-colored chips.

Potatoes should not be shipped in mixed loads of commodities that include apples or pears, from which potatoes absorb odors. Also, apples and pears may acquire an earthy taste and odor if shipped with potatoes.

***Recommended loading methods:***

- *Bags* — Potatoes are packed in 50-lb (22.7-kg) paper and netted bags or paper or plastic film consumer bags holding 5 or 10 pounds (2.3 or 4.5 kg). The smaller-sized bags are packed in polyethylene or paper master bags holding 50 pounds (22.7 kg). The large bags are usually palletized and secured by straps or netting. Load hand-stacked bags into trailers in a pyramid pattern (Figure 31b) to reduce wall contact. Use airflow or center loading with spacer blocks for pallets in trailers. This helps prevent freezing or chilling injury. Use 9-11 loading of pallets in marine containers, being sure to use spacer blocks in units with flat walls (Figure 38). Bags of potatoes may be shipped in railcars with no specific loading pattern, but it is not a recommended practice.
- *Fiberboard cartons* — Potatoes packed in consumer bags are also packed in 50-lb (22.7-kg) fiberboard cartons. The cartons are usually palletized and secured by glue, straps, or netting. Hand stack cartons of new potatoes in an airflow pattern (Figure 38c) to allow in-transit drying. Hand stack cartons of late crop potatoes shipped from storage in winter in an offset-by-layers pattern (Figure 31a) to reduce contact of potatoes with the walls and chance of freezing. Use airflow or center loading with spacer blocks for pallets in trailers; block stow individual cartons and use 9-11 loading of pallets in marine containers, being sure to use spacer blocks in units with flat walls (Figure 38).
- *Bulk bins and tote bags for tablestock* — Tablestock potatoes are often shipped in plastic bins or bulk bags for repacking at the receiver. Bins

may be double-stacked; however, the bins must not be overfilled to avoid crushing the potatoes in the lower bin. Bulk bags cannot be stacked.

- *Bulk potatoes for chipping* — Most potatoes for chipping are shipped from storage in bulk loads (i.e., loose, without packaging). Construct bulkheads 2 to 4 feet (0.6 to 1.2 m) from the rear doors of the trailers to contain the loose potatoes. Place heaters in this open space when required. Loading and transport should be conducted at the same or slightly warmer temperature than the storage temperature, but never at colder temperatures. Potatoes should be handled as gently as possible to avoid bruising. Because of the danger of low-temperature sweetening, truckers should carry an accurate thermometer for checking pulp temperatures of the potatoes. Bulk chipping potatoes usually are loaded with a bin-piler conveyor with a telescoping boom. They are unloaded with an industrial truck or by gravity flow.

Chipping potatoes shipped from far northern states in the winter require heating in temperature controlled semi-trailers to avoid low-temperature sweetening and freezing injury. Also allow a small amount of outside air to ventilate chipping potatoes at all times. Operate the fan to circulate fresh air to all parts of the load. Chipping potatoes should be processed as soon as possible after unloading.

## **Radicchio (see Leafy Greens)**

### **Radishes**

#### ***Recommended transport conditions:***

- *Desired transit temperature:*  
32°F (0°C)
- *Desired relative humidity:*  
95 to 100 percent
- *Highest freezing point:*  
30.7°F (-0.7°C)
- *May be package-iced or top iced*

Field heat should be quickly removed by hydrocooling to minimize dehydration and preserve natural crispness. Topped radishes packed in consumer bags keep well in transit and storage for several weeks, provided the recommended temperature and humidity are maintained. Radishes that are not topped are very sensitive to moisture loss and must be cooled

and handled to maintain moist conditions. Black spotting is a major market disease of radishes, but is controlled under proper temperature management.

***Recommended loading methods:***

- *Waxed fiberboard cartons with consumer packages; fiberboard cartons or wirebound crates (bunches with tops); polyethylene bags (bulk radishes)* — Most radishes are topped and packed in consumer-size plastic film packages, which are shipped in waxed, corrugated fiberboard cartons. Some topped radishes are packed bulk in polyethylene bags for food service. Radishes with tops are bunched and packed with ice in fiberboard cartons or wirebound crates. See “Ice” under “Refrigeration Methods” in section I for further information about icing. If package ice or top ice is used, the cartons must be moisture-resistant, and floor drains should be open so that meltwater will not accumulate on the vehicle floor. The cartons and crates are usually palletized and secured by glue, straps, or plastic netting. Use airflow or center loading with spacer blocks for pallets in trailers; block stow individual cartons and use 9-11 loading of pallets in marine containers, being sure to use spacer blocks in units with flat walls (Figure 38).

**Rambutan**

***Recommended transport conditions:***

- *Desired transit temperature:*  
50° to 54°F (10° to 12°C)
- *Desired relative humidity*  
90 to 95 percent
- *Highest freezing point:*  
30.5°F (-0.8°C) estimated

Rambutan fruit should be ripe and completely red, as they do not continue ripening after harvest. Rambutans should be cooled using forced-air cooling because they are fairly perishable, with a shelf life of only 1 to 3 weeks at the optimum temperature range of 50° to 54°F (10° to 12°C). Rambutans are quite susceptible to water loss, which results in skin browning and shriveling and browning of the ‘spinterns’ (hairs or soft spines) on the fruit surface. Rambutan varieties differ in their susceptibility to chilling injury, which causes dark maroon or bronze discoloration of the skin and spinterns.

***Recommended loading methods:***

- *Fiberboard cartons* — Rambutans are shipped loose-filled in fiberboard cartons with plastic film liners. The cartons are usually palletized with

vertical and horizontal bands or plastic netting. Use airflow or center loading with spacer blocks for pallets in trailers; block stow individual cartons and use 9-11 loading of pallets in marine containers, being sure to use spacer blocks in units with flat walls (Figure 38).

## Raspberries

### ***Recommended transport conditions:***

- *Desired transit temperature:*  
32°F (0°C)
- *Desired relative humidity:*  
90 to 95 percent
- *Highest freezing point:*  
Black raspberries: 30.0°F (-1.1°C)  
Red raspberries: 30.9°F (-0.6°C)

Raspberries are extremely perishable, being highly susceptible to mechanical damage and fungal decays. To minimize bruising, they are typically field-packed into rigid, vented 'clamshell' packages, often with an absorbent pad on the bottom, then placed in single-layer cartons ('flats'). Raspberries should be forced-air cooled as close to 32°F (0°C) as possible within 2 hours of harvest. Under the very best conditions their market life is 7 to 10 days. Only sound fruit should be shipped, because decay fungi easily spread from fruit to fruit. Truck shipments of raspberries may be mixed loads with blackberries and strawberries, which have similar packaging and transit requirements. Raspberries are subject to various types of mold, which can be controlled most effectively by rapidly precooling and holding the berries at the desired 32°F (0°C) temperature immediately after harvest.

### ***Recommended loading methods:***

- *Open-top fiberboard tray cartons* — Virtually all raspberries are picked into rigid, vented 'clamshell' packages packed into single-layer cartons ('flats'). Tabs serve to interlock the layers. Sheets are inserted between the layers during stacking to further solidify the pallet. Strap the flats securely to the pallets to minimize bouncing and rotating of the berries from highway shock and vibration, a major cause of physical damage to berries during transit. Use airflow or center loading with spacer blocks for pallets in trailers; use 9-11 loading of pallets in marine containers, being sure to use spacer blocks in units with flat walls (Figure 38). For additional protection against decay and to extend shelf life, some palletized loads of raspberries may have airtight plastic bags sealed over

the pallets that have been injected with 10 to 20% carbon dioxide (CO<sub>2</sub>) (Figure 42).

## **Rhubarb**

### ***Recommended transport conditions:***

- *Desired transit temperature:*  
32°F (0°C)
- *Desired relative humidity:*  
95 to 100 percent
- *Highest freezing point, stalks:*  
30.3°F (-0.9°C)

Cool fresh rhubarb quickly using hydrocooling and maintain at 32°F (0°C) at a high humidity to prevent wilting and shriveling in order to achieve the maximum potential shelf life of about 4 weeks. Bunches or loose stalks of rhubarb are usually wrapped in polyethylene film liners before packing in shipping cartons to prevent moisture loss. Do not seal the liners, and ensure the cartons or crates are well vented to allow refrigerated air to remove respiration heat and prevent mold development. Rhubarb should not be shipped in mixed loads with green onions, from which rhubarb absorbs odors.

### ***Recommended loading methods:***

- *Fiberboard cartons* — Rhubarb is packed as topped bunches or loose stalks in plastic film-lined fiberboard cartons. The cartons are usually palletized and secured by glue, straps, or plastic netting. Use airflow or center loading with spacer blocks for pallets in trailers; block stow individual cartons and use 9-11 loading of pallets in marine containers, being sure to use spacer blocks in units with flat walls (Figure 38).

## **Romaine Lettuce [see Lettuce (Romaine)]**

## **Salad Mixes (see Fresh-cut Fruits and Vegetables)**

## **Satsumas (see Mandarins)**

## **Spinach (see Greens)**



## Sprouts (alfalfa, bean, onion, pea)

### **Recommended transport conditions:**

- *Desired transit temperature:*  
32°F (0°C)
- *Desired relative humidity:*  
95 to 100 percent
- *Highest freezing point:*  
31.5°F (-0.3°C)
- *Do not top ice*

Sprouts are among the most perishable fresh fruits and vegetables and must be handled carefully to prevent breakage of the turgid stems and roots to minimize decay. Sprouts should be cooled immediately after harvest by forced-air cooling, hydrocooling, or vacuum cooling. Packaging in perforated film bags will keep relative humidity high and minimize shriveling during marketing; rigid 'clamshell' packages also provide protection from damage. These packages are then packed in master cartons for shipping. They are usually ordered in small lots and shipped in mixed loads with other commodities. These crops are very sensitive to ethylene, so do not ship with ethylene-producing crops. Under optimal conditions, the shelf life of sprouts is 5 to 10 days.

### **Recommended loading methods:**

- *Waxed, fiberboard cartons and wirebound crates* — Sprouts in consumer bags or 'clamshells' are packed in fiberboard cartons. The cartons are usually palletized and secured by glue, straps, or plastic netting. Use airflow or center loading with spacer blocks for pallets in trailers; block stow individual cartons or crates and use 9-11 loading of pallets in marine containers, being sure to use spacer blocks in units with flat walls (Figure 38).

## Squash and Pumpkins

### **Recommended transport conditions:**

Winter squash (Hubbard and acorn) and pumpkins

- *Desired transit temperature:*  
50° to 55°F (10° to 13°C)

- *Desired relative humidity:*  
50 to 70 percent
- *Highest freezing point:*  
30.5°F (-0.8°C)

Summer squash (yellow crookneck and straightneck, scallop and zucchini)

- *Desired transit temperature*  
41° to 50°F (5° to 10°C)
- *Desired relative humidity*  
95 percent
- *Highest freezing point:*  
31.1°F (-0.5°C)
- *Do not top ice*

**Winter squashes and pumpkins** can be room cooled in field bins or lugs with adequate ventilation to 50°F (10°C) with low relative humidity (50% to 70%) and stored for 2 to 6 months. However, they are subject to chilling injury, so they should not be stored or shipped at lower temperatures. Curing immediately after harvest may prove beneficial to some squash types by healing mechanical cuts. Squash is cured by holding for 10 to 20 days at 80° to 85°F (27° to 29°C), then cooled and stored.

**Summer squashes** are harvested at an immature stage, and are therefore more perishable than winter squash. The skin is very tender and summer squash must be carefully handled to minimize wounds. They are hydrocooled or forced-air cooled for rapid removal of field heat prior to packing in small cartons. Compared to winter squashes, summer squashes can be stored at lower temperatures but require high relative humidity; under best conditions storage life is up to 14 days. Summer squashes are chilling-sensitive but can withstand short exposure (up to 2 days) at 32° to 40°F (0° to 4°C) without development of chilling injury symptoms.

***Recommended loading methods:***

- *Fiberboard cartons and wirebound crates* — Most summer squash are packed in loose-filled waxed, fiberboard cartons. Winter squash and pumpkins may be packed in either unwaxed fiberboard cartons or wirebound crates. The cartons and crates are usually palletized and secured by glue, straps, or plastic netting. Use airflow or center loading with spacer blocks for pallets in trailers; block stow individual cartons and

use 9-11 loading of pallets in marine containers, being sure to use spacer blocks in units with flat walls (Figure 38).

- *Bulk-bins* — Pumpkins often are shipped in bulk bins. If the bins are double stacked, take care not to overfill the bins, or pumpkins in the lower bins will be crushed. Also take care not to block ventilation between the layers when stacking solid wall fiberboard bins.

## **Starfruit (see Carambola)**

### **Strawberries**

#### ***Recommended transport conditions:***

- *Desired transit temperature:*  
32°F (0°C)
- *Desired relative humidity:*  
90 to 95 percent
- *Highest freezing point:*  
30.6°F (-0.8°C)

Strawberries are extremely perishable, being highly susceptible to mechanical damage and fungal decays. To minimize bruising, they are typically field-packed into rigid, vented 'clamshell' packages in single-layer cartons ('flats'). Strawberries should be forced-air cooled as close to 32°F (0°C) within 2 hours of harvest. Under the very best conditions, their market life is 10 to 14 days. Only sound fruit should be shipped, because decay fungi easily spread from fruit to fruit. Truck shipments of strawberries are usually straight loads, but they may sometimes be shipped in mixed loads with blackberries and raspberries, which have similar packaging and transit requirements. Strawberries are subject to various types of mold, which can be controlled most effectively by rapidly precooling and holding the berries at the desired 32°F (0°C) temperature immediately after harvest.

#### ***Recommended loading methods***

- *Open-top fiberboard tray cartons* — Virtually all strawberries are picked into rigid, vented 'clamshell' packages packed into single-layer cartons ('flats'). Tabs serve to interlock the layers. Sheets are inserted between the layers during stacking to further solidify the pallet. Strap the flats securely to the pallets to minimize bouncing and rotating of the berries from highway shock and vibration, a major cause of physical damage to berries during transit. Use airflow or center loading with spacer blocks for pallets in trailers; use 9-11 loading of pallets in marine containers, being sure to use spacer blocks in units with flat walls (Figure 38).

For additional protection against decay and to extend shelf life, some palletized loads of strawberries may have airtight plastic bags sealed over the pallets that have been injected with 10% to 20% carbon dioxide (CO<sub>2</sub>) (Figure 42).

## **Summer Squash (see Squash and Pumpkins)**

### **Sweet corn**

#### ***Recommended transport conditions:***

- *Desired transit temperature:*  
32°F (0°C)
- *Desired relative humidity:*  
95 to 98 percent
- *Highest freezing point:*  
30.9°F (-0.6°C)
- *May be package-iced or top iced*

Sweet corn is either hand-harvested and field packed into shipping cartons, or increasingly, it is mechanically harvested into bins and hand-packed at the cooling facility. Sweet corn is very perishable and should be cooled as soon possible after harvest. Hydrocooling is the primary cooling method and it leaves the ears moist; vacuum-cooling is used to a lesser extent. Since most commercial varieties are ‘supersweet’ types that retain kernel sugar content for longer periods than older varieties, the main causes for quality loss are drying of the husk leaves, and moisture loss and toughening of the kernels. Supersweet sweet corn has more than double the potential storage life of traditional sweet corn (2 to 3 weeks versus 4 to 8 days), but still loses sweetness from respiration if not kept near 32°F (0°C). Because of its high respiration rate, sweet corn requires maximum refrigeration during transit. Sweet corn should not be shipped in mixed loads with green onions, from which sweet corn absorbs odors.

#### ***Recommended loading methods:***

- *Waxed fiberboard cartons, RPCs, and wirebound crates* — Most sweet corn packages contain 48 to 56 place-packed ears. Consumer packs contain ears that have been trimmed to uniform length and the husks partially or completely removed prior to placement on trays and overwrapping with plastic film. The trays are subsequently packed into fiberboard cartons. The cartons and crates are usually palletized with or without vertical and horizontal bands or plastic netting. Use airflow

or center loading with spacer blocks for pallets in trailers; block stow individual cartons and use 9-11 loading of pallets in marine containers, being sure to use spacer blocks in units with flat walls (Figure 38).

Some sweet corn loads in trailers are hand stacked, usually with top icing for wirebound crates and package icing for cartons. Load wirebound crates lengthwise on their sides and load cartons lengthwise on their bottoms. Align the rows of crates, keeping adequate space between them to allow for top ice. Place wooden strips horizontally across the top of each layer of crates to prevent the crates from toppling and blocking the space between rows. Load cartons in register so the meltwater can run through the openings in the top and bottom of the cartons.

If package ice or top ice is used, the cartons must be moisture-resistant, and floor drains should be open so that meltwater will not accumulate on the vehicle floor. See “Ice” under “Refrigeration Methods” in section I for further information about icing.

## **Sweetpotatoes**

### ***Recommended transport conditions:***

- *Desired transit temperature:*  
55° to 60°F (13° to 16°C)
- *Desired relative humidity:*  
85 to 90 percent
- *Highest freezing point:*  
29.7°F (-1.3°C)

Sweetpotatoes are harvested in late summer or early fall. Care must be taken during harvest to minimize cuts and abrasions in the thin peel. After harvest, most sweetpotatoes are cured to heal harvest injuries by holding the unwashed roots from 4 to 7 days at 80° to 86°F (26.7° to 30°C) and a high relative humidity (85% to 95%). After curing they can be room-cooled to 55° to 60°F (13° to 16°C) with adequate ventilation for shipping from storage throughout the year. Preparation for shipping includes washing, sorting, and sometimes being treated with an approved fungicide and/or wax coating. Sometimes uncured (‘green’) sweetpotatoes are shipped immediately to market but they require careful handling to prevent skin breaks and decay.

Sweetpotatoes are subject to chilling injury at temperatures below 50°F (10°C), even if only for a few hours, which may impair their appearance, taste, texture and increase decay. Sprouting may occur when handled at

temperatures above 60°F (16°C); temperatures above 70°F (21°C) may favor development of decay.

***Recommended loading methods:***

- *Fiberboard cartons* — Sweetpotatoes are predominantly shipped in loose-fill fiberboard cartons of various sizes, and some are packed in wirebound crates, or in polyethylene bags packed into cartons. The cartons and crates are usually palletized and secured by glue, straps, or plastic netting. Use airflow or center loading with spacer blocks for pallets in trailers; block stow individual cartons and use 9-11 loading of pallets in marine containers, being sure to use spacer blocks in units with flat walls (Figure 38).

**Tangerines (see Mandarins)**

**Tomatoes, round, roma, grape, cherry**

***Recommended transport conditions:***

- *Desired transit temperature:*  
55° to 70°F (13° to 21°C)
- *Desired relative humidity:*  
90 to 95 percent
- *Highest freezing point:*  
31°F (-0.6°C)

**Round and roma types:**

Field-grown round and roma tomatoes are often harvested at mature-green stage into field bins or gondola wagons. They should be handled carefully to minimize mechanical damage. Internal bruising is an internal discoloration that develops during ripening and is only visible after slicing the ripe tomato. Studies have shown that a single drop from 12 inches (30 cm) can induce internal bruising in mature-green and ripening round tomatoes. Roma tomatoes are not quite as sensitive due to having thicker locular walls.

Following harvest and packing, most mature-green tomatoes are loaded in ethylene ripening rooms at 70°F (21°C) and 85% to 90% relative humidity for 48 to 72 hours to initiate uniform ripening. After ethylene treatment, the tomatoes are room-cooled to 55° to 70°F (13° to 21°C) to promote normal ripening during storage and transport. After harvest, roma tomatoes in field bins may be loaded directly into ripening rooms for ethylene treatment. Some mature-green tomatoes are shipped without ethylene treatment, to be ripened by tomato re-packers.

Vine-ripened, or pink, round and roma tomatoes are harvested after reaching breaker stage (when there is a visible change in color). These tomatoes may be field-grown or grown under protected culture, such as greenhouses or high tunnels. Vine-ripened tomatoes do not require ethylene treatment since ripening has already begun. Tomatoes on-the-vine (TOV) are typically greenhouse-grown, and are hand-harvested with stems attached at pink or above ripeness stage.

Tomatoes at mature-green through the light-red stage (60% to 90% red color) may develop chilling injury if stored or shipped at temperatures below 50° to 55°F (10° to 13°C), depending on the ripeness stage, with riper tomatoes able to tolerate lower temperatures. Chilling injury causes tomatoes to ripen with poor quality, including off-colors and lack of typical tomato flavor and aroma; severe symptoms include sunken, black lesions that may favor decay. Storing and shipping tomatoes from 65° to 80°F (18° to 27°C) favors ripening, but may result in extensive decay; ripening above 80°F results in poor development of red color.

**Grape, cherry types:**

For best flavor quality, grape and cherry tomatoes should be harvested near full-red stage. Although they are almost exclusively hand-harvested into field lugs, these miniature tomatoes are quite resistant to mechanical damage and can be mechanically harvested with little damage using proper equipment. Temperature management is the same as described above for round and roma types.

**Recommended loading methods:**

- *Fiberboard cartons* — Round and roma tomatoes are mostly loose-filled into partial-telescope, 20- or 25-lb (9.1- to 11.3-kg) fiberboard cartons; grape and cherry tomatoes may be packed in smaller, 10-lb (4.7-kg) loose-filled cartons. Vine-ripe round tomatoes are place-packed into plastic trays that have cells to hold individual fruit. The trays are packed in fiberboard cartons with two or three layers per carton. Tomatoes-on-the-vine (TOV) are packed in single-layer, open, fiberboard cartons ('trays'). Grape and cherry tomatoes are most commonly packed into rigid, 'clamshell' packages and the clamshells packed into master cartons for palletizing. A tacky glue is commonly applied to the carton lids prior to palletizing for stability. The palletized trays are secured by straps or plastic netting. Use airflow or center loading with spacer blocks for pallets in trailers; block stow individual cartons and use 9-11 loading of pallets in marine containers, being sure to use spacer blocks in units with flat walls (Figure 38).

## Watermelons

### ***Recommended transport conditions:***

- *Recommended transit temperature:*  
50° to 60°F (10° to 16°C)
- *Recommended relative humidity:*  
90 percent
- *Highest freezing point:*  
31.3°F (-0.4°C)

Watermelons can incur serious losses from cracks and bruises due to improper handling and loading. Bruising makes them more susceptible to decay. When harvesting directly into trailers, a cushioning material on the trailer floor can reduce damage. For local distribution, watermelons may be held under ambient temperature (shaded) with ventilation. However, most watermelons are packed into bulk bins or cartons for shipment to distant locations. The fruit should not be packed higher than the bin sidewalls to avoid crushing when stacked. Watermelons should be room-cooled to 50° to 60°F (10° to 16°C); they can develop chilling injury when held or shipped below 50°F (10°C). Chilling injury symptoms include pitting, off-flavors, and fading of the flesh color. Watermelons are very sensitive to exposure to ethylene gas and should not be shipped with ethylene-producing crops.

### ***Recommended loading methods:***

- *Fiberboard cartons* — Fiberboard cartons may contain two to six watermelons. The cartons are usually palletized and secured by glue, straps, or plastic netting. Use airflow or center loading with spacer blocks for pallets in trailers; block stow individual cartons and use 9-11 loading of pallets in marine containers, being sure to use spacer blocks in units with flat walls (Figure 38).
- *Bulk bins* — Bulk bins of watermelons may weigh from 800 to 1200 pounds (363 to 554 kg). Bins can be stacked two-high in the trailer. To prevent crushing of watermelons, check to be sure the fruit don't extend above the bin sidewalls. Also, take care not to block ventilation between the layers when stacking solid wall fiberboard bins.

**Winter Squash (see Squash and Pumpkins)**

**Yellow Crookneck or Straightneck Squash (see Squash and Pumpkins)**

**Yuca (see Cassava)**

**Zucchini (see Squash and Pumpkins)**



## CANNED FOODS

Foods that can be safely stored at room temperature, or “on the shelf,” are called ‘shelf stable.’ These non-perishable products include jerky, country hams, canned and bottled foods, rice, pasta, flour, sugar, spices, oils, and foods processed in aseptic or retort packages and other products that do not require refrigeration until after opening. Not all canned goods are shelf stable. Some canned food, such as some canned ham and seafood, are not safe at room temperature (see discussion below). The packaging of these products will be labeled, “Keep Refrigerated.”

Damage claims for canned goods cost carriers millions of dollars annually. There are two major causes of damage to canned foods during distribution — mechanical and temperature. Improper handling causes mechanical damage, dented or broken cans and bottles, and is responsible for the greatest percentage of claims. A smaller percentage of the claims results from improper temperature conditions, which cause rusting of the cans or freezing of the contents.

Damage is caused to canned goods in many ways, such as:

- poorly sealed cases;
- careless handling of cans during processing and warehousing;
- improper stacking on pallets;
- careless handling with mechanical-lift trucks;
- loose or slack loading in the vehicle;
- improper bracing, wrapping, or strapping; and
- failure to brace remainder of the load after a dropoff.

Poorly sealed cases may let cans or jars fall out during handling. Check cases of canned goods periodically during loading for indications of damage. Do not accept a heavily damaged load.

Currently, most canned goods are unitized for warehousing and shipment. Mishandling of pallets with mechanical-lift trucks and poor stacking of cases on the pallets are important sources of damage. Stack the cases so that they are flush with the edges of the pallet. If the cases overlap the edges of the pallet, lift trucks may push against the canned goods instead of the pallet during handling. If there is a space between the outside edges of the stack and the pallet edges, considerable slack space may be left between the pallets after they are loaded in the vehicle. This may allow the cases to shift during transit.

Another source of damage is loose pallet boards. A loose edge board will allow pressure to be exerted on the cases in the bottom layer, when the pallet is lifted with a forklift truck. Keep pallets in good repair at all times.

A large percentage of the unit loads of canned goods are stretch- or shrink-wrapped with plastic film before shipment. This assures integrity of the pallet loads and reduces damage claims.

Tight loading is important, whether the shipment is unitized or hand-loaded. Any slack space that lets the cases shift or fall may result in damaged goods. Load the cases or pallet units snugly together and brace the end of the last stack. In a split shipment, brace and block the end of the last stack before moving to the next dropoff. Use spacers or inflatable dunnage to fill out crosswise slack. All pallets or stacks should be the same height, unless precautions are taken by bracing or otherwise, to prevent the uneven top layer from shifting. Truck drivers cannot control all damage that may occur before and during loading. However, they can reduce the chances of being blamed for damage beyond their control by being alert for damaged goods and not accepting them. They also can control the damage by closely supervising the loading of their vehicles. A good slogan for haulers of canned goods is, "The only right load is a tight load."

The most frequent type of temperature damage to canned foods is rusting of tin cans. Rusting is caused by condensation on cans removed from a low-temperature environment to one with a higher temperature. Condensation causes rust spots on the cans and wrinkling of the labels and may make the product unmarketable. Also, after a period of storage, the rust spots may pinhole the cans with leaks and allow the product to spoil. To prevent rust-causing condensation, do not unload canned foods in warm warehouse areas which have previously been subjected to low temperatures, until they have had time to warm up to 50°F (10°C) or above.

Freezing is not likely to damage the canned food product itself. However, freezing a canned product may endanger the package integrity or break a glass package. To protect canned food against freezing damage during transit through areas of intense cold, apply thermostatically controlled heat to keep the product from freezing. See Table 7 for the freezing points of some canned foods.

Extended exposure of canned foods to 90°F (32°C) or above temperatures is detrimental to product quality. In some cases, exposure to these higher temperatures may result in total product loss through thermophilic spoilage.

In the case of some canned foods such as crabmeat, there are food safety considerations if the vacuum-packed goods are exposed to the maximum cumulative exposure time and internal product temperatures needed for potential growth and toxin formation by *C. botulinum* Type E and nonproteolytic Types B and F. In reduced oxygen packaged products in which refrigeration is the sole barrier to outgrowth of non-proteolytic *C. botulinum* and the spores have not been destroyed (e.g., vacuum packaged refrigerated raw fish, vacuum-packaged refrigerated unpasteurized crayfish meat, and reduced oxygen packaged unpasteurized Dungeness crabmeat), the temperature should be maintained below 38°F (3.3°C) from packing to consumption. These canned foods should optimally be transported at 32° to 34°F (0° to 1.2°C). For more detail, refer to the Seafood and Food Safety sections.

**Table 7.** Freezing temperature of selected canned foods.

PRODUCT	FREEZING POINT	
	°F	°C
Applesauce	27.6	(-2.4)
Asparagus	30.2	(-1.0)
Beans, green stringless	30.3	(-0.9)
Beans, lima	29.6	(-1.3)
Beans, with pork	28.8	(-1.8)
Beans, strained	30.6	(-0.8)
Beans, wax, cans	30.3	(-0.9)
Beans, wax, glass jars	30.2	(-1.0)
Beets	30.4	(-0.9)
Carrots	30.3	(-0.9)
Catsup	19.4	(-7.0)
Chili sauce	23.7	(-4.6)
Corn, creamed	29.6	(-1.3)
Corn, in brine	29.4	(-1.4)
Corn, vacuum-packed	29.7	(-1.3)
Cranberry sauce	16.3	(-8.7)
Grapefruit juice	30.2	(-1.0)
Milk, evaporated	29.4	(-1.4)
Mushrooms	29.8	(-1.2)

PRODUCT	FREEZING POINT	
	°F	°C
Peaches, heavy syrup	28.6	(-1.9)
Peaches, light syrup	27.6	(-2.4)
Pears	27.6	(-2.4)
Peas, Alaska	31.0	(-0.6)
Peas, sweet	29.3	(-1.5)
Pea soup	27.7	(-2.4)
Potted meat	26.0	(-3.3)
Pumpkin	30.7	(-0.7)
Salmon	27.2	(-2.7)
Sardines	28.2	(-2.1)
Spiced meat	22.2	(-5.4)
Spinach	30.8	(-0.7)
Succotash	29.9	(-1.2)
Sweetpotatoes ('yams')	29.2	(-1.6)
Tomatoes	30.8	(-0.7)
Tomato juice	29.8	(-1.2)
Tomato soup	27.4	(-2.6)
Tuna	26.3	(-3.2)
Vinegar	28.7	(-1.8)

## DAIRY PRODUCTS

### Butter and Margarine

#### ***Recommended transport conditions:***

- *Desired transit temperature:*
  - Butter (fresh): 39°F (4°C)
  - Butter (frozen): -10°F (-23°C)
  - Margarine: 35°F (2°C)
- *Desired relative humidity:*
  - Butter: 75 to 85 percent
  - Margarine: 60 to 70 percent

Butter and margarine usually are shipped from cold storage and are at the desired transit temperature when loaded. They are packed in fiberboard boxes that provide some insulation and allow the product to be exposed to room temperatures for short periods during loading and unloading without the risk of serious damage. However, during shipment the products must be refrigerated at the recommended temperatures to prevent softening and quality deterioration. Butter and margarine absorb odors very easily. Trucks or trailers previously used for hauling odorous products, such as fish, cabbage, or onions, should be well cleaned and aired before being loaded with butter or margarine. See “Cleaning and Sanitation” under section II, “Preparation for Loading” for hints on removing odors from trailers.

***Recommended loading methods:***

- *Fiberboard boxes* — Load boxes either crosswise or lengthwise on their bottoms on pallets or the truck floor. If the products are at the desired transit temperature when loaded, stack the boxes as tightly together as possible to retain that temperature. In hot weather, take care to prevent heat conducted through the walls and floor from melting the product. To prevent this, provide space for refrigerated air to circulate around the perimeter of the load. Some vehicles are equipped with deep channel floors and ribbed walls for this purpose. If not, attach spacer strips vertically to the interior sidewalls to provide air space between the product and the walls. For hand-stacked loads place pallets on the floor with the stringers running lengthwise to allow air circulation under the load. Center load pallets in vehicles without ribbed walls to reduce heat transfer across walls (Figure 38a).

**Cheeses**

***Recommended transport conditions:***

- *Desired transit temperature:*  
34° to 40°F (1° to 4°C)
- *Desired relative humidity:*  
65 to 70 percent
- *Highest freezing point:*

Variable by variety. Also, freezing may result in textural changes; see text.

Cheeses need to be protected from heat and cold. Most cheeses tend to ‘oil off’ at 68°F (20°C) and above. During oiling off, the fat leaks from the body, and the cheese quickly becomes rancid.

On the other hand, subjecting some types of cheeses to freezing temperatures will result in texture changes that may not be acceptable to consumers. As a general rule, cheese should not be held at temperatures below 30°F (-1°C) or above 50°F (10°C).

The recommended temperatures for transporting and holding some common types of cheeses are shown in Table 8.

**Table 8.** Ideal temperatures for transporting common types of cheese. (adapted from ASHRAE Handbook — Refrigeration)

CHEESE	IDEAL TRANSIT TEMPERATURE	
	°F	°C
Brick	30 to 34	(-1.1 to 1.1)
Camembert	30 to 34	(-1.1 to 1.1)
Cheddar	30 to 34	(-1.1 to 1.1)
Cottage	30 to 34	(-1.1 to 1.1)
Cream	32 to 34	(0.0 to 1.1)
Limburger	30 to 34	(-1.1 to 1.1)
Neufchatel	32 to 34	(0.0 to 1.1)
Process American	40 to 45	(4.4 to 7.2)
Process brick	40 to 45	(4.4 to 7.2)
Process Limburger	40 to 45	(4.4 to 7.2)
Process Swiss	40 to 45	(4.4 to 7.2)
Roquefort	30 to 34	(-1.1 to 1.1)
Swiss	30 to 34	(-1.1 to 1.1)
Cheese foods	40 to 45	(4.4 to 7.2)

**Recommended loading methods:**

- *Fiberboard boxes* — Load boxes either crosswise or lengthwise on their bottoms on pallets or the truck floor. If the products are at the desired transit temperature when loaded, stack the boxes as tightly together as possible to retain that temperature. In hot weather, take care to prevent heat conducted through the walls and floor from melting the product. To prevent this, provide space for refrigerated air to circulate around the perimeter of the load. Some vehicles are equipped with deep channel floors and ribbed walls for this purpose. If not, attach spacer strips vertically to the interior sidewalls to provide air space between the product and the walls. For hand-stacked loads, place pallets on the floor

with the stringers running lengthwise to allow air circulation under the load. Center-load pallets in vehicles without ribbed walls to reduce heat transfer across walls (Figure 38a).

## Ice Cream

### ***Recommended transport conditions:***

- *Desired transit temperature:*  
-20° to -15°F to (-29° to -26°C)

To maintain top quality, ice cream must be kept at the desired transit or holding temperature. It also is very important to keep the temperature of ice cream constant during loading and unloading. Fluctuating temperatures cause the ice crystals in ice cream to increase in size. Frequent temperature fluctuations will increase the crystal size to the point where the ice cream is no longer acceptable to the consumer.

Trucks used for hauling ice cream should be built specifically for that purpose.

### ***Recommended loading methods:***

- *See “Frozen Foods.”*

## FROZEN FOODS

### ***Recommended transport conditions:***

- Frozen foods should be kept at 0°F (-18°C) or lower from the time they are first frozen until readied for consumption.

By way of example, the condition of seafood is influenced by intrinsic factors, holding conditions prior to freezing, packaging and/or glaze and storage/transportation temperatures. Among the factors that are important are the original quality of the raw seafood, the processing method, the packaging material, and the method used for the final product.

Seafood begins to spoil immediately after death. Spoilage is manifested by undesirable flavors, softening of the flesh, and eventually substantial losses of fluid containing protein and fat. By lowering the temperature of the dead seafood, spoilage can be retarded, and if the temperature is kept low enough, spoilage can be significantly suppressed.

Microbiological, chemical, biochemical, and physical changes can take place in the flesh of seafood after freezing and during storage and/or

transportation. These undesirable changes are exacerbated by elevated holding temperatures and are retarded by lower holding temperatures. If the holding temperature is below 14°F (-10°C), freezing will stop spoilage because spoilage organisms (bacteria, yeasts, and molds) cease to function below 14°F (-10°C). However, chemical, biochemical, and physical processes leading to irreversible changes will still occur.

Some transfer of moisture from the product is unavoidable during freezing and frozen storage. Moisture loss leads to dehydration of the seafood. Moreover, fluctuating holding temperatures, such as those encountered during transportation, are a major cause of dehydration. Dehydrated, frozen seafood has a dry, wrinkled appearance and is pale or white in color, with spongy flesh.

As an example, hoarfrost inside bags of shrimp is the result of the direct sublimation of gaseous water from the shrimp (freezer burn) that later on becomes ice crystals. Frost can develop when food (IQF shrimp) is not frozen properly/adequately and/or when the temperature of the freezer is not maintained at a proper level of 0°F (-18°C) or colder.

Various types of frozen seafood have different shelf lives in frozen cold storage, depending on how quickly they develop abnormal flavors and if they readily discolor. As a basic premise, researchers have found that shelf life of seafood can be extended significantly at colder storage temperatures.

As a general rule, the shelf life of food is defined as the maximum length of time a given product is fit for human consumption. Correspondingly, the shelf life of seafood is typically considered the time from when the seafood is taken from the water until it is no longer fit to eat. In other words, the shelf life is equivalent to the duration of consumer acceptability. The relationship between the shelf life of frozen seafood and storage temperature is shown below (Figure 43)

The importance of low temperature cold storage for frozen seafood is sometimes referred to as the Time-Temperature Tolerance concept. According to the World Food Logistics Organization (WFLO), this concept concludes:

*“There is, for every frozen product, a relationship between storage temperature and the time it takes at this temperature for the product to undergo a certain amount of quality change.”*

*“Changes during storage and distribution at different temperatures are cumulative and irreversible over the entire storage period and sequence is without influence on the size of the accumulated total quality change.”*



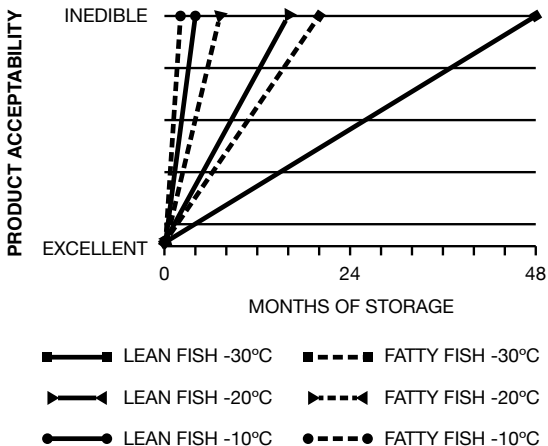

**Figure 43.** Effects of storage temperature on shelf life of frozen fish products. (Source: *Storage of Frozen Seafood Fact Sheet*, Canadian Institute of Fisheries Technology)

In keeping with the Time-Temperature Tolerance concept, the difference in shelf life of various types of seafood is shown in the table below (Table 9). These tables were taken from the IIR Guide to Refrigerated Storage.

**Table 9.** Storage life for frozen seafood at different temperatures.

TYPE OF SEAFOOD	STORAGE LIFE (MONTHS)		
	0°F (-18°C)	-13°F (-25°C)	-22°F (-30°C)
Fatty fish, sardines, salmon, ocean perch	4	8	12
Lean fish, cod, haddock	8	18	24
Flat fish, flounder, plaice, sole	9	18	24
Lobster, crabs	6	12	15
Shrimp	6	12	12

The WFLO offers the following guidance concerning of the damaging effects of elevated temperatures on frozen foods:

If the highest reading is 25°F (-3.9°C) or higher:

*“Damage to quality is occurring rapidly and immediate steps should be taken to prevent further damage. Product should be placed in a blast freezer or equally rapid freezer with spacers between cases to permit air*

*circulation and rapid temperature drop. Cases should not be removed to storage room or restacked until product is at 0°F (-18°C) or lower. Product which has been above 25°F (-3.9°C) should be evaluated after it has been returned to 0°F (-18°C) or below. It may no longer have acceptable quality. Even if quality is still acceptable, the remaining shelf life is short.”*

If the highest readings are 10°F (-12°C) or higher, but below 25°F (-3.9°C):

*“Damage to quality is occurring slowly but at an unacceptable rate. To prevent further damage, it is necessary to place the product in 0°F (-18°C) or lower temperature within an hour. If this is not done, damage to quality can be expected. If the product has risen above 10°F (-12°C), air circulation should be provided between cases. Even if the quality is still acceptable, the life of product with readings above 10°F (-12°C) is significantly reduced. Steps should be taken to rotate this inventory quickly.”*

Fluctuating temperatures during distribution degrade the market quality of frozen foods. Re-cooling frozen foods to the thermostat set point after even a slight temperature rise causes moisture to migrate from the product to the colder surfaces of the packaging materials. This results in product dehydration and undesirable frost buildup inside the packages. Product quality losses will increase with the amount of temperature rise and frequency of re-cooling. Sensory changes are those perceived with the senses, i.e., appearance, odor, texture and taste. The first sensory changes of fish during storage are concerned with appearance and texture.

Frozen foods thaw between 15°F and 32°F (-9° and 0°C). Although the changes are not easily recognized, even at temperatures as low as 0°F (-18°C), frozen foods may deteriorate from fat oxidation and enzymatic changes. Certain microorganisms also may develop at temperatures around 20°F (-7°C) and above, adding to deterioration and contamination of the food. The higher the temperature, the greater the rate of deterioration.

Ensure that transportation units transporting frozen food are:

- clean and free from dirt, debris, odors, or any substance that may contaminate the food;
- constructed, insulated, and equipped with adequate refrigeration capacity and air delivery system to continuously maintain a product temperature of 0°F (-18°C) or colder; and
- precooled by setting the thermostat at 0°F (-18°C) and letting the refrigeration unit operate for at least one-half hour before loading, or until a temperature gradient is established across the insulation. Be sure to schedule adequate time for precooling in warm weather.

**Recommended loading methods:**

Load boxes of frozen foods in a solid block, avoiding contact with the walls. Ensure that air refrigerated at or below 0°F (-18°C) circulates around all sides of the load to prevent the transfer of heat through the trailer to the frozen product (Figures 17 and 18). Floor channels, floor racks, or pallets 2 1/4 inches (6 cm) or more deep will facilitate air circulation under the load.

Provide at least 4 inches (10 cm) of space between the load and the rear doors to let air flow freely around the rear of the load. For vehicles without ribbed walls, attach vertical stripping (1 or more inches thick) on the sidewalls to facilitate air circulation between the walls and load. Leave at least 10 inches (25 cm) of space between the ceiling and the top of the load for unobstructed airflow over the load.

A great deal of frozen food is shipped on pallets or slip sheets. Center load pallets in vehicles without ribbed walls to reduce heat transfer across walls (Figure 38a). Block or brace the load to keep the product from toppling against the walls.

If supplemental or emergency refrigeration is needed for a frozen food shipment, place solid carbon dioxide (CO<sub>2</sub>) in the form of dry ice or snow on top of the load. Keep the fans running at low speed to uniformly distribute cool air around the load.

**WARNING:** The gas CO<sub>2</sub> may cause asphyxiation. Vent the vehicle properly before entering.

**FRESH AND CURED MEAT AND FRESH SEAFOOD**

Meat products are highly perishable, and growth of microorganisms inherent on meat carcasses is a major cause of deterioration. Proper refrigeration is necessary to retard the growth of these microorganisms and preserve the fresh physical appearance of the meat products. Dehydration also affects the appearance and marketability of fresh meat. Table 10 gives the recommended temperatures and humidities for transporting some fresh meat, seafood, and processed meat products.

Fresh meats absorb odors readily, so do not load in vehicles retaining strong residual odors from other products. Do not ship meats in mixed loads with strong odor-producing products, such as fish, apples, citrus, pineapples, or onions.

**Table 10.** Recommended temperatures and humidities for protecting selected fresh, cured, and processed meat and seafood products during transit. (Source: ASHRAE Refrigeration Handbook)

COMMODITY	TEMPERATURE		RELATIVE HUMIDITY (%)
	°F	°C	
Fresh meats:			
Beef	32 to 34	0.0 to 1.1	88 to 92
Lamb	32 to 34	0.0 to 1.1	85 to 90
Pork	32 to 34	0.0 to 1.1	85 to 90
Poultry	28 to 32	-2.2 to 0.0	85 to 90
Rabbits	32 to 34	0.0 to 1.1	90 to 95
Veal	32 to 34	0.0 to 1.1	90
Cured and processed meats:			
Bacon:			
Cured, farm style	61 to 64	16.0 to 18.0	85
Cured, packer style	34 to 39	1.0 to 4.0	85
Dried beef (chipped)	50 to 59	10.0 to 15.0	15
Frankfurters	32	0.0	85
Hams:			
Light cure	37 to 41	3.0 to 5.0	80 to 85
Country cure	50 to 59	10.0 to 15.0	65 to 70
Pork sausages (links or bulk country and Polish)	32	0.0	85
Fresh fish:			
Haddock, Cod, Perch	31 to 34	-0.6 to 1.1	95 to 100
Hake, Whiting	32 to 34	0.0 to 1.1	95 to 100
Halibut	31 to 34	-0.6 to 1.1	95 to 100
Herring:			
Kippered	32 to 36	0.0 to 2.2	80 to 90
Smoked	32 to 36	0.0 to 2.2	80 to 90
Mackerel	32 to 34	0.0 to 1.1	95 to 100
Menhaden	34 to 41	1.1 to 5.0	95 to 100
Salmon	31 to 34	-0.6 to 1.1	95 to 100
Tuna	32 to 36	0.0 to 2.2	95 to 100

COMMODITY	TEMPERATURE		RELATIVE HUMIDITY (%)
	°F	°C	
Shellfish:			
Scallop meat	32 to 34	0.0 to 1.1	95 to 100
Shrimp	31 to 34	-0.6 to 1.1	95 to 100
Lobster (American)	41 to 50	5.0 to 10.0	In sea water
Oyster, clams (meat and liquid)	32 to 36	0.0 to 2.2	100
Oysters in shell	41 to 50	5.0 to 10.0	95 to 100

## Meat

In the United States, nearly all meat animal carcasses are broken into wholesale or retail cuts, film packaged, and packed in fiberboard cartons before shipment. Most wholesale beef cuts are vacuum packaged in plastic film. If not vacuum-packed, cuts are usually individually wrapped before boxing or packed in a plastic bag liner inside the boxes. The packaging materials greatly reduce the chance of microbial contamination and dehydration of the meat during transport. However, the insulating effect of the boxes and packaging film make it imperative that the meat be at the desired transit temperature when packed and loaded. The truck and container's refrigeration system are not designed to remove heat remaining in the meat.

The bacterial safety and rate of spoilage of chilled meat depends upon the numbers and types of microorganisms initially present, the rate of growth of those microorganisms, the conditions of storage/transit (temperature and gaseous atmosphere) and the characteristics (pH, water activity  $a_w$ ) of the meat. Of these factors, temperature is by far the most important.

By way of example, the maximum storage life of chilled pork is achieved when the meat is stored at the lowest possible temperature, without the product freezing. In practice, the optimum storage temperature is 29°F (-1.5°C) for boxed, chilled pork in MAP (Modified Atmosphere Packaging). Stated differently, one hundred percent (100%) of the storage life attainable is obtained at 29°F (-1.5°C). Moreover, the chilled meat product temperature, rather than ambient temperature, must be monitored to adequately manage the shelf life of chilled pork.

Carbon dioxide in the package environment (i.e., in MAP) gives chilled pork a storage life up to 12 weeks at 0°C. Reportedly, chilled pork packed in 10% CO<sub>2</sub> (i.e., MAP) can be stored for a period of 40 days at 39°F (4°C).

Reduction in storage life is notably affected with increases in the storage/transit temperature.

With regard to food safety, a number of bacterial pathogens capable of causing food poisoning in humans are known to contaminate chilled meat. Reported minimum and optimum growth temperatures for those pathogens commonly associated with red meat are show below (Table 11).

**Table 11.** Minimum and optimum temperatures for growth of human pathogens on red meat.

PATHOGENS (RED MEAT)	MINIMUM TEMPERATURE		OPTIMUM TEMPERATURE	
	°F	°C	°F	°C
<i>Campylobacter</i> spp.	86	30	108 to 109	42 to 43
<i>Clostridium perfringens</i>	54	12	109 to 117	43 to 47
<i>E. coli</i> strains (such as O157:H7)	41	5	95 to 109	35 to 43
<i>Listeria monocytogenes</i>	32	0	95 to 109	35 to 43
<i>Yersinia enterocolitica</i>	28	-2	82 to 84	28 to 29

Some pathogens, such as *L. monocytogenes*, are capable of growth at chill temperatures below 41°F (5°C). These pathogens are a particular concern in relation to refrigerated meats since refrigeration cannot be relied on to prevent growth. On the other hand, illnesses caused by *L. monocytogenes* and *E. coli* are often due to inadequate cooking before ingestion.

**Recommended loading methods for meat:**

Fiberboard cartons — Since meat does not produce respiratory heat, stack the boxes of meat tightly together on pallets or slip sheets. The same principle applies here as applies to frozen foods. Keep a blanket of cold air (i.e., a cold air envelope) circulating around the load to remove heat transferred across the walls, ceiling, doors, and floor of the trailer. Center load pallets in vehicles without ribbed walls to reduce heat transfer across walls (Figure 38a). With regard to reefer containers with flat (i.e., non-corrugated) sidewalls, hand-stowed chilled meat and frozen foods should be stowed on wooden floor racks and thin wooden spacers should be placed between the container sidewalls and the cargo. This approach will develop a cold-air envelope around the load and help protect the hand-stowed chilled meat and frozen cargo from the warm ‘T’ floor and sidewalls. For USDA

phytosanitary reasons, wood dunnage needs to be treated and certified as insect-free in order to enter the U.S. from overseas locations.

In warm, humid weather, precool trucks, containers, and truck trailers hauling boxes of meat before loading to prevent moisture from condensing on cold interior of the transit vehicle and on cold cartons as they are loaded from refrigerated storage. Condensation creates conditions favorable for the growth of spoilage microorganisms. Moisture also will condense on cold cartons when doors are opened for delivery stops in warm weather. If at all possible, all loading and unloading should be in refrigerated areas.

## Seafood

Fresh and frozen fish are perishable. Shelf life is the time from when it is taken from the water until it is no longer fit to eat. Temperature and handling practices are the two most important factors in determining the shelf life of all species of fish. If the fish product is handled properly, the temperature at which it is held controls its useful life. Temperature controls the rate of bacterial spoilage and enzyme breakdown. The higher the temperature the faster fish spoil. Fresh tropical fish typically keep longer at 32°F (0°C) than fresh fish from cold and temperate waters.

With regard to food safety, temperature management is critical for fresh seafood and fresh meat. As a case in point, a key consideration when determining the wholesomeness and suitability of the crabmeat for human consumption is the maximum cumulative exposure time and 'internal' product temperatures needed for potential growth and toxin formation by *C. botulinum* Type E and nonproteolytic Types B and F.

According to the FDA and others, "There is a safety concern with crabmeat because there is an increased potential for the formation of *C. botulinum* toxin before spoilage makes the product unacceptable to consumers."

The plot (Figure 44) shown below is referred to as the 'Skinner and Larkin Curve.' This plot is routinely referenced to determine minimum times and temperatures for *C. botulinum* growth and toxin formation. The zone below the curve represents 'safe' conditions where *C. botulinum* toxin liberation has not been observed. The zone above the curve represents potentially 'dangerous' conditions, which could result in liberation of *C. botulinum* toxin. This plot represents an extremely conservative boundary between safe and dangerous handling conditions. Moreover, this plot is reportedly utilized by the FDA in their determinations. The Skinner-Larkin data (Figure 44) indicate that it would take 9 days at 41°F (4°C) to pose a potential risk for *C. botulinum* toxin production, at the earliest.

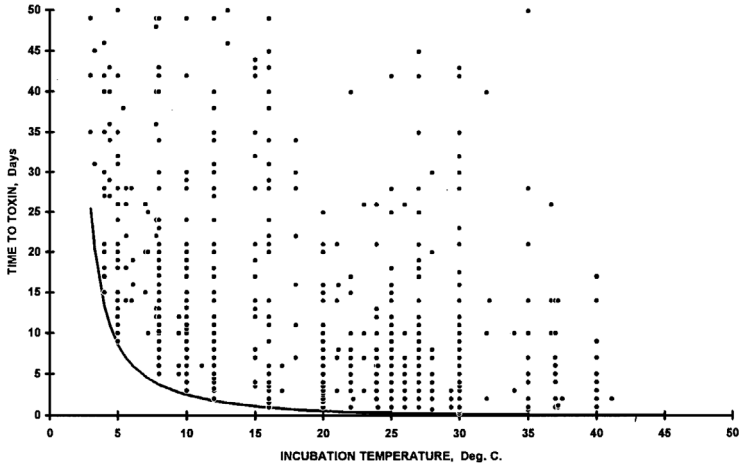

**Figure 44.** Boundary conditions for *Clostridium botulinum* toxin formation at various storage temperatures. • = data from the literature; — = predicted boundary. (Source: Skinner and Larkin. 1998. *J. Food Prot.* 61, 1154-1160)

Significantly, it is a common misconception that elevated ambient air temperature excursions inside the cargo space of a refrigerated trailer or container are the same as the internal product temperatures. This assumption is simply not correct. Air temperatures change much more quickly than internal product temperatures and, as a result, air temperatures should not be considered the same as internal product temperatures. The FDA guidelines clearly indicate ‘internal’ product, not ‘ambient’ air, temperatures.

## POULTRY AND EGGS

### Poultry (fresh and hard-chilled)

#### **Recommended transport conditions:**

- *Desired transit temperatures:*  
Fresh, 26° to 34°F (-3° to 1°C)  
Hard-chilled, 0°F to 26°F (-18° to -3°C)
- *Desired relative humidity:*  
90 to 95 percent
- *Average freezing point:*  
27°F (-3°C)



Fresh poultry is shipped by two methods, fresh and hard-chilled. After the birds are dressed, they are chilled to 40°F (4°C) or lower. At this point they may be packed in bins, boxes, or crates, with or without ice, and shipped for further processing or for immediate retail. Fresh poultry has a relatively short shelf life of a week or so at most.

Once the poultry is thawed, the spoilage of poultry is clearly dependent on the storage temperature and the number of microorganisms (also called the 'microbiological load') present as well as the composition of the microflora. These important interrelated factors directly affect shelf life of chilled poultry. In other words, the type of microflora and the storage temperature limits shelf life.

Shelf life of poultry is dependent on sanitation, temperature, and packaging. Most chilled poultry is maintained at temperatures of 28° to 38°F (-2° to +4°C) during marketing. The low temperature assures cell contraction and reduces tissue weepage. Most hard-chilled poultry is broken into retail cuts and packaged in foam trays overwrapped with vapor-proof plastic film. If the poultry is in good initial condition, additional shelf life may be obtained by vacuum packaging and gas flushing.

The following table gives the expected shelf life of chilled poultry, assuming good commercial processing, at several storage temperatures (Table 12).

**Table 12.** Shelf life of chilled poultry at different storage/transport temperatures. (Source: Potter, N. 1995. Food Science. Springer)

STORAGE/ TRANSPORT TEMPERATURE	°F	70	50	40	35	32	30
	°C	21	10	4	2	0	-1
TIME (DAYS)		1	3	6	12	18	30

At elevated temperatures between 40° and 140°F, attention should be given to the possible growth and development of foodborne (food poisoning) organisms associated with poultry. These pathogens can multiply at temperatures between 40° and 140°F. It is important to point out that freezing or chilling temperatures do not kill these bacteria and that they are only destroyed by thorough cooking of any food to 160°F.

#### ***Recommended loading methods:***

- *Pallets* — Most poultry is packed in fiberboard boxes and palletized for shipment. Ensure that the poultry is at the desired transit temperature when loaded. Secure the boxes to the pallets with strapping or stretch

film to prevent them from toppling. Center-load pallets in vehicles without ribbed walls to reduce heat transfer across walls (Figure 38a).

## Shell Eggs

### **Recommended transport conditions:**

- *Desired transit temperature:*  
35° to 40°F (1.7° to 4.4°C)
- *Desired relative humidity:*  
70 to 80 percent
- *Average freezing point:*  
28.0°F (-2°C)

Shell eggs are fragile and highly perishable. Even though it is not outwardly visible, egg quality deteriorates rapidly under poor environmental conditions.

Thoroughly clean and precool the transportation unit to at least 45°F (7°C) before eggs are loaded. Since eggs absorb odors, ensure that the vehicle is free of residual odors. Do not ship eggs in mixed loads, especially not with citrus fruits, onions, or potatoes.

Because of their perishability and the insulating effect of the fiberboard boxes and cartons in which they are shipped, precool eggs to their desired transit temperature before they are loaded. Also, because the boxes are stacked tightly and may be secured on pallets with stretch film or strapping, there is little or no cooling air circulating through the load. FDA regulations indicate that eggs destined for consumer markets be precooled to at least 45°F (7°C) prior to loading and kept at or below this temperature during transit.

To prolong the shelf life of eggs, the ideal conditions include keeping them at temperatures between 35° and 40°F (1.7° and 4.4°C) and a relative humidity of 70% to 80%. With regard to food safety, the shell egg temperature is of concern due to the role of temperature in *Salmonella enteritidis* growth. Considering only *S. enteritidis* bacteria that are inside the egg soon after laying, research evidence indicates that growth of the bacteria depends on an increase in the permeability of the vitelline (yolk) membrane. This increase allows the bacteria access to critical growth nutrients. However, the change in permeability of the yolk membrane is time and temperature dependent. The process may take 3 weeks or longer, depending on the temperature at which the eggs are held. Until this process is complete, there is little or

no growth of *S. Enteritidis* bacteria within the egg. Essentially, this period represents a lag phase for the bacteria.

In short, the internal egg temperature can enhance the growth of potentially harmful microorganisms. A family of bacteria called *Enterobacteriaceae*, which includes *Salmonella*, *Escherichia*, *Enterobacter*, *Klebsiella*, and *Yersinia* species can contaminate eggshells. If the eggs are handled or processed improperly, the bacteria can remain on the shells until they reach the consumer. Fewer bacteria on the surface of the egg shells means fewer pathogens can get into the egg when they are cracked in preparation for consumption. Importantly, *S. enteritidis* will not grow in egg products held at 45°F (7°C) or less. Additionally, *Listeria monocytogenes* will reportedly not grow in whole egg below 41°F (5°C).

**Recommended loading methods:**

- *30- and 15-dozen fiberboard boxes* — Nearly all eggs shipped in these boxes are palletized, 6 or 12 boxes per layer, on 48- x 40-inch pallets. However, to maximize use of space in the trailer, hand stack one row of boxes between the pallet rows in the middle of the trailer. Stack two rows of boxes between the pallet rows in some 102-inch (2.6-m) wide trailers.

Because eggs are so fragile, loading and bracing to prevent cargo movement is essential. To prevent forward shifting, load the first pallets snugly against the bulkhead, leaving no lengthwise slack between the pallets until the end of the load. If the pallet load heights are uneven, use loadlock bars across the truck at the top layer to prevent forward or rearward shifting. Or, in some cases, tape the top one or two layers of the pallet loads horizontally to prevent shifting.

Road shock and vibration are pronounced at the rear of the truck. Therefore, take extra care to secure the load in this area. This may be accomplished by shrink-wrapping the pallet loads at the rear doors (Figure 45) and by using load-lock bars across the top of the load.

- *Plastic crates* — One-dozen cartons of eggs are shipped in plastic crates holding 15 or 30 cartons. The cartons are retailed directly from the crates. The crates fold or nest for easy return to the egg packing plant.
- *Roll-on/off carts* — These carts hold 360, 1-dozen cartons of eggs. They are positioned on the truck so that the cartons will not slide or shift off the carts. The carts are braced or secured with load lock bars. The carts are rolled off the truck and onto the retail floor where the eggs are sold off the cart. Empty carts fold for less space on the return haul.



**Figure 45.** A palletized load of eggs. Stretch film is wrapped around the pallet loads to reduce the possibility of vibration damage, but is twisted once per side so as to not completely seal the pallet loads – avoiding potential moisture buildup. (Source: P.E. Brecht)

---

## VI. Regulatory Considerations for Truck Construction Materials, Cleaning Compounds, and Sanitation

The Food and Drug Administration (FDA), in implementing the Food Safety Modernization Act (FSMA; (Pub. L. 111-353) established the rule for the Sanitary Transportation of Human and Animal Food (STF). The STF sets “...the requirements for shippers, loaders, carriers by motor vehicle and rail vehicle, and receivers engaged in the transportation of food, including food for animals, to use sanitary transportation practices to ensure the safety of the food they transport.” (81 FR 20091). The STF also applies to shipments of food from other countries to the U.S. by any means, when the food is then transferred to a motor vehicle or rail vehicle for transportation within the U.S., and the food is then consumed or distributed in the U.S.

The STF states that vehicles and transportation equipment “...must be designed and of such material and workmanship to be suitable and adequately cleanable for their intended use to prevent food from becoming unsafe.” Other than vehicles, the term ‘transportation equipment’ includes such things as bulk and non-bulk containers, bins, totes, pallets, pumps, fittings, hoses, gaskets, and loading and unloading systems. Although USDA and the Department of Transportation (DOT) may conduct inspections, generally violations are reported to the FDA, which is responsible for enforcing the STF rule. It’s also necessary to be aware of State laws since, in most cases, a more stringent provision in State law would not be preempted by the STF.

Materials and cleaning compounds used in transportation vehicles are potential food contact substances in the same sense as food-processing equipment, baskets, crates, boxes, and plastic or paper wrapping. Sanitizers, disinfectants, pesticides, or lubricants that may be used on transportation vehicles or equipment must be used in compliance with the same rules that apply to food processing facilities regulated by USDA and FDA. That is, those compounds must either be a GRAS (Generally Recognized As Safe) substance or of food grade quality and allowed for contact with food or food contact surfaces; otherwise, they must be used in a manner that does not contaminate the food contact surface or must be thoroughly removed by washing and rinsing after use.

Potential food contact substances need to be evaluated by FDA if they will be in direct contact with a food product and there is a chance that the material will impart a toxic substance, cause off-colors or odors, provide a possible source of microbial contamination because of the inability to readily clean, or otherwise contaminate the food. Carcass meats and bulk loads of fresh fruits and vegetables are products more likely to contact the surfaces of transport vehicles.

Contact the FDA's Office of Food Additive Safety (OFAS) for more information on packaging and food contact substances.. The OFAS contacts can be found at <https://www.fda.gov/Food/IngredientsPackagingLabeling/PackagingFCS/default.htm>; the main phone number is (240) 402-1200.

---

## **VII. Food Safety Considerations for Transporting Perishable Foods by Truck**

Food safety for sanitary transportation of food has become a critical concern with implementation of the 2016 FDA Sanitary Transportation of Human and Animal Food (STF) rule. The STF rule requires that shippers, loaders, carriers, and receivers involved in transportation of human and animal food use documented sanitary practices to ensure the safety of that food. The rule is part of the larger effort to implement the Sanitary Food Transportation Act of 2005 (2005 SFTA) and the Food Safety Modernization Act of 2011 (FSMA).

The goal of the STF rule is to prevent practices during transportation that create food safety risks, such as failure to properly refrigerate food, inadequate cleaning of vehicles between loads, and failure to properly protect the food from contamination and spoilage. The FSMA Preventive Controls Rules require food manufacturers to consider the transportation needs of foods that they manufacture when they develop their food safety plans. There must be a food safety plan in place when transporting foods that was prepared, or its preparation overseen, by at least one preventive-controls-qualified individual, also known as a PCQI. The PCQI identifies the hazards requiring preventive controls associated with the facility and the food it stores and transports, as well as the appropriate preventive controls and preventive control management components.

Companies that transport foods must have in place preventive measures and best handling practices that include:

- Personnel training;
- Refrigerated equipment maintenance programs;
- Sanitation and cleaning programs;
- Adequate cargo and equipment precooling procedures;
- Verifiable, suitable cargo stowage; and
- Assured maintenance of specified internal product temperatures during transport and storage.

Shippers, loaders, carriers, and receivers are required to communicate with each other regarding preventive measures, such as temperature control or equipment cleaning, including sharing their written procedures.

The FDA Food Code has identified foods that can support proliferation of pathogenic microorganisms as 'Time/Temperature Control for Safety' (TCS) foods. Those foods must be maintained no warmer than 41°F (5°C) at all times to ensure food safety. This requirement includes the transportation portion of the food handling system. Transportation equipment must be capable of maintaining food products at or below 41°F (5°C) to comply with the food code.

At the same time, for fresh produce such as sprouts, cut melons, cut leafy greens, and cut tomatoes that are classified as TCS foods, it is important that transport temperatures not be allowed to fall below around 32°F (0°C) to avoid freezing injury. In this regard, computerized reefer units offer significant benefits to transportation companies, shippers, and receivers for conducting the required food safety programs. The reefer's computerized temperature management system computer includes various levels of guarded access,

thereby protecting selected food-safety-related critical control limits from tampering and unwelcome changes. The computerized system also permits an operator, such as a truck driver, to set up pre-determined temperature management and food safety conditions for various foods. The advanced microprocessors and air distribution systems available for refrigerated trailers and containers offer transportation companies valuable 'off-the-shelf' food safety solutions.

Some of the features of computerized truck trailer and marine container refrigeration units for compliance with food safety rules are listed below. These can be incorporated directly into the carrier and shipper's plan for sanitary transportation of food. In addition, these features help reduce problems that can result in food quality losses irrespective of food safety issues.

- **Operator Decisions.** Tasks like thermostat setting, upper and lower temperature limits, rate of temperature reduction, operating modes, and defrost initiation can be pre-programmed into the reefer unit's microprocessor.
- **Expert Systems.** These can take complex commodity and food safety related decision-making out of the hands of the operator and others by utilizing the knowledge of experts to assist the carrier in setting up custom-tailored computerized systems for the safe and sanitary transport of food.
- **Start of Trip.** The 'start of trip' feature creates a record of when the carrier assumed care and custody of the food, indicating when the accountability shifts from the shipper to the carrier to the receiver.
- **Computerized Pre-trip.** The pre-trip is a functionality test of the refrigeration unit. Pre-tripping the reefer unit and documenting the time and date of pre-trip is a key ingredient to a sanitary food transportation plan and to preventing losses and mitigating claims.
- **Anti-tampering & Flashing Set Point.** This is an anti-tampering feature that prevents the set point temperature from being inadvertently or maliciously changed. In addition, reefer units feature flashing set points and audible signals that warn the operator that he/she needs to enter the set point.
- **Confusion over F versus C degrees.** This guarded access feature ensures that large F or C degree symbols are prominently shown on the screen and limits authority to pre-program the reefer unit using either F or C to the carrier company management only. This feature helps eliminate human error and confusion.

- **Upper and Lower Thermostat Set-Point Limits.** This involves setting and locking ‘critical’ and ‘operating’ upper and lower temperature limits during food transport. The upper critical limit is the temperature that, if exceeded, the safety of the product may be compromised. The operating limit is set lower than the critical limit so that, if it is triggered, a carrier can take corrective action to fix the problem before it becomes ‘critical.’ Lower limits are for minimizing unwanted freeze and chill damage, with the critical limit being the freezing or chilling temperature of the products, and the operating limit being set higher to allow corrective action to be taken before damage occurs if it is triggered.
- **Recordkeeping & Verification.** The reefer unit’s microprocessor/data logger provides the required recordkeeping and verification that carriers can utilize for their plans for the sanitary transportation of food. Data loggers also offer a means for fast retrieval and storage of information as well as graphs, tables, and printouts for recording and verifying times and temperatures and many other events during transit.
- **Proper cargo stowing** is a critical practice for ensuring food safety and quality. Short cycling of conditioned air due to poor stowage and damaged air delivery chutes in trailers can lead to hot spots in a load, which in turn increases the risk of a food poisoning event and a myriad of types of cargo losses. Improper stowage is a leading cause of poor temperature management and cargo losses. Inadequate airflow resulting from poor stowage of food can also be a root cause of food safety problems and violations. Training personnel and practicing proper cargo stowing should also be part of carrier’s and shipper’s plans for sanitary transportation of food.
- **Packaging and Food Safety.** Packaging conditions that reduce the amount of oxygen and/or increase the amount of carbon dioxide present in the package (e.g., vacuum packaging and modified atmosphere packaging) extend shelf life by inhibiting the growth of spoilage microorganisms and altering physiological and/or biochemical processes in food. Reduced oxygen packaging raises a safety concern for some foods such as meats seafood, and certain fresh and processed vegetables because there may be an increased potential for the formation of toxin by *C. botulinum*, a strictly anaerobic organism, before spoilage makes the product unacceptable to consumers. *C. botulinum* forms toxin more rapidly at higher temperatures than at lower temperatures. The minimum temperature for growth and toxin formation by *C. botulinum* type E and nonproteolytic types B and F is 38°F (3.3°C). For type A and proteolytic types B and F, the minimum temperature for growth is 50°F (10°C). As the shelf life of refrigerated foods is increased,



more time is available for *C. botulinum* growth and toxin formation. As the transit temperatures increase, the time required for toxin formation is significantly shortened. In these instances, refrigeration serves as a prudent second barrier.

# Appendix I.

---

## ESTIMATING MOBILE REFRIGERATION REQUIREMENTS

Estimate the number of Btu's of heat load when there is any question as to whether the vehicle's refrigeration system has adequate capacity. This is particularly important in hot weather, if the pulp temperature of the product at loading is considerably above the desired transit temperature. Shippers who often receive claims of loss from decay should make calculations to determine if the refrigeration capacity is adequate for each load.

Consider the following three factors in estimating the heat load or amount of refrigeration needed to obtain and maintain the proper temperature during transit:

1. Field or sensible heat (Hf) left in the commodity and package
2. Heat of respiration (Hr)
3. Amount of heat leakage (HI) through the walls of the trailer

Add these three factors to get the total number of Btu's that must be absorbed by the refrigeration system.

**Field heat (Hf)** is the amount of heat that has to be removed from the product and the containers before the desired transit temperature is reached. In practice, products may not have been pre-cooled to the desired transit temperature. This extra refrigeration requirement must be allowed for – **it is likely that the vehicle refrigeration and air distribution systems will not be capable of removing field heat.** To calculate field heat load, use the specific heat (Sp.ht.) of the product (Table I-1) and container, the weight (Wt.) of the product and container, and the temperature differential (TD) as shown in the following formula:

$$H_f = SP.ht. \times Wt. \times TD = Btu$$

**Heat of respiration (Hr)** can be determined by using the information in Table I-2, which gives the amount of heat generated by 1 ton of a product in 24 hours at different temperatures. To calculate the respiration heat, the following formula can be used:

$$H_r = \text{Respiration rate (at average transit temperature)} \times \text{time (no. of days)} \times Wt. \text{ (tons)} = Btu$$

**Heat leakage (HI)** through the trailer body is estimated by determining:

- the coefficient of heat transfer (Ua factor) of the trailer body;

- the temperature differential between the thermostat setting and the average expected outside temperature; and
- the number of hours the product will be in the vehicle.

The Ua factor for a particular trailer body depends on many variables — type and thickness of insulation, air leakage, differential between the outside and inside air temperatures, and others. Therefore, for the purpose of estimating heat leakage it is impractical to give the details of all calculations needed to determine the Ua factor. However, the Ua factor based on a standard method of rating can be supplied by the manufacturers of some trailers. If the Ua factor is not readily available, use the following for general estimation of heat load:

- A factor Ua = 140 Btu/°F/hour may be used for a modern 48-foot trailer with 2.5 inches of plastic foam sidewall insulation.
- If the trailer has been in service over 3 years, then a factor of 180 Btu/°F/hour should be used to account for aging-related deterioration of the insulation and door seals.

$$HI = Ua \times TD \times \text{time (hours)} = \text{Btu}$$

**Table I-1.** Specific heat above and below freezing of certain perishable products. (adapted with permission from ASHRAE Handbook — Refrigeration)

	BTU/LB/°F			BTU/LB/°F	
	ABOVE	BELOW		ABOVE	BELOW
<b>FRUITS AND VEGETABLES</b>					
Apples	0.87	0.45	Limes	0.89	0.46
Apricots	.88	.46	Mangoes	.85	.44
Artichokes (globe)	.87	.45	Mushrooms	.93	.47
Asparagus	.94	.48	Nectarines	.86	.44
Avocados	.72	.40	Okra	.92	.46
Bananas	.80	.42	Onions (dry)	.90	.46
Beans:			Oranges	.90	.46
Green snap	.91	.47	Parsley	.88	.45
Lima	.73	.40	Parsnips	.84	.44
Beets (roots)	.90	.46	Peaches	.91	.46
Blackberries	.88	.46	Pears	.86	.45
Blueberries	.86	.45	Peas (green)	.79	.42

	BTU/LB/°F			BTU/LB/°F	
	ABOVE	BELOW		ABOVE	BELOW
Broccoli	.92	.47	Peppers (sweet)	.94	.47
Brussels sprouts	.88	.46	Pineapples	.88	.45
Cabbage	.94	.47	Plums and fresh prunes	.88	.45
Cantaloupes	.93	.48	Potatoes:		
Carrots	.90	.46	Early-crop	.85	.44
Casaba and Crenshaw melons	.94	.48	Late-crop	.82	.43
Cauliflower	.93	.47	Prunes (see plums)		
Celery	.95	.48	Pumpkins	.92	.47
Cherries (sweet)	.84	.44	Radishes	.95	.48
Corn (sweet)	.79	.42	Raspberries:		
Cranberries	.90	.46	Black	.84	.44
Cucumbers	.97	.49	Red	.87	.45
Eggplant	.94	.48	Rhubarb	.95	.48
Endive and Escarole	.94	.48	Romaine (see Lettuce)		
Figs (fresh)	.82	.43	Spinach	.94	.48
Garlic (dry)	.69	.40	Squash:		
Gooseberries	.90	.46	Summer	.95	.48
Grapefruit	.90	.46	Winter	.88	.45
Grapes	.86	.45	Strawberries	.92	.47
Honeydew melons	.94	.48	Sweetpotatoes	.76	.41
Kale	.89	.46	Tangerines	.90	.46
Leeks	.88	.46	Tomatoes (ripe)	.95	.48
Lemons	.91	.46	Watermelons	.97	.48
Lettuce (head)	.96	.48			

	BTU/LB/°F			BTU/LB/°F	
	ABOVE	BELOW		ABOVE	BELOW
<b>DAIRY, MEAT AND POULTRY PRODUCTS</b>					
Bacon	.38	.26	Lamb (fresh)	.72	.40
Beef (fresh)	.77	.41	Milk	.93	.46
Butter	.36	.25	Oleomargarine	.32	.25
Cheese	.52	.31	Pork (fresh)	.53	.31
Eggs (shell)	.73	.40	Poultry (fresh)	.80	.42
Egg solids (whole)	.22	.21	Smoked sausage	.62	.35
Egg yolk solids	.23	.21	Veal (fresh)	.74	.40
Ice cream	.70	.39			
Hams:					
Cured	.67	.37			
Fresh	.53	.31			

**Table I-2.** Approximate amount of respiration heat produced by certain fruits and vegetables at the temperatures indicated.<sup>1</sup>

COMMODITY	BTU PER TON PER 24 HOURS <sup>2</sup>					
	32°F (0°C)	41°F (5°C)	50°F (10°C)	59°F (15°C)	68°F (20°C)	77°F (25°C)
Apples:						
Fall	660	1,320	1,980	3,300	4,400	—
Summer	1,100	1,760	3,740	5,500	6,820	—
Apricots	1,320	1,980	4,180	7,480	11,440	—
Artichokes	7,700	10,450	15,620	26,400	40,700	50,050
Asparagus	13,200	23,100	47,300	51,700	59,400	93,250
Avocados	—	5,500	—	24,050	46,250	60,050
Bananas (green)	—	—	—	4,850	7,400	—
Beans:						
Green snap	7,250	10,300	12,760	38,100	49,200	—
Lima (in pod)	4,450	6,100	—	24,700	34,300	—
<sup>1</sup> Source: USDA Handbook No. 66. 1968, 1986, & 2016 <sup>2</sup> To convert "Btu per ton per 24 hours" to "kcal per metric ton per 24 hours", multiply by 0.278.						

COMMODITY	BTU PER TON PER 24 HOURS <sup>2</sup>					
	32°F (0°C)	41°F (5°C)	50°F (10°C)	59°F (15°C)	68°F (20°C)	77°F (25°C)
Bean sprouts	5,060	9,240	21,120	—	—	—
Beets	2,700	4,100	5,650	7,200	—	—
Blackberries	4,100	7,950	13,640	38,350	—	—
Blueberries	1,400	2,350	6,380	10,550	15,300	22,250
Broccoli	4,620	7,480	17,820	37,400	66,000	—
Brussels sprouts	8,800	15,400	32,320	44,000	60,720	—
Cabbage	1,200	2,200	3,960	4,900	8,450	12,350
Carrots (topped)	3,300	4,300	6,820	8,750	15,500	—
Cauliflower (trimmed)	3,900	4,500	7,480	10,100	17,700	24,650
Celery	1,600	2,400	6,820	8,200	14,200	—
Cherries:						
Sour	2,100	2,850	—	8,500	9,800	13,650
Sweet	1,050	2,600	6,160	7,700	—	—
Corn (sweet)	8,950	13,850	23,100	35,850	63,700	78,900
Cranberries	650	950	1,760	—	3,200	—
Cucumbers	—	—	5,720	6,380	6,820	8,140
Endive and Escarole (see Leaf Lettuce)						
Figs (fresh)	1,320	2,860	4,620	12,320	16,720	21,010
Gooseberries	1,700	2,850	5,060	11,440	17,820	—
Grapefruit	—	1,000	1,760	3,100	4,250	—
Grapes:						
American	600	1,200	1,760	3,500	7,200	8,500
European	400	1,000	1,760	2,420	5,940	6,600
Kale (whole leaves)	4,700	8,900	17,160	30,250	46,900	—
Leeks	2,900	5,350	13,200	21,950	—	24,850
Lemons	700	1,250	2,420	3,650	4,850	5,350

<sup>1</sup>Source: USDA Handbook No. 66. 1968, 1986, & 2016

<sup>2</sup>To convert "Btu per ton per 24 hours" to "kcal per metric ton per 24 hours", multiply by 0.278.

COMMODITY	BTU PER TON PER 24 HOURS <sup>2</sup>					
	32°F (0°C)	41°F (5°C)	50°F (10°C)	59°F (15°C)	68°F (20°C)	77°F (25°C)
Lettuce:						
Head	2,500	3,650	6,820	8,450	12,200	18,100
Leaf	5,100	6,450	8,580	13,800	22,100	32,200
Limes	—	800	1,800	2,200	2,800	6,650
Mangoes	—	3,520	7,700	12,760	24,860	26,400
Melons:						
Cantaloupes	1,200	2,050	3,300	7,950	12,000	14,700
Honeydew	—	1,760	3,080	5,280	6,600	7,260
Watermelons	—	800	1,760	—	4,650	—
Mushrooms	7,900	15,600	21,340	46,000	63,800	—
Nectarines (see Peaches)						
Okra	—	12,250	20,020	32,050	57,400	75,900
Onions:						
Dry	650	750	1,540	2,400	3,650	6,200
Green	4,620	6,160	10,780	19,910	28,270	33,880
Oranges	880	1,320	1,760	3,960	6,160	7,150
Parsnips	3,000	2,900	4,840	8,250	—	—
Peaches	1,150	1,700	4,400	8,300	17,750	22,350
Pears:						
Bartlett	1,100	1,650	3,190	8,250	11,000	—
Kieffer	450	—	—	3,850	4,750	5,300
Peas (green, in the pod)	8,580	14,080	19,580	38,720	60,060	79,200
Peppers (sweet)	—	1,540	2,640	5,940	7,480	12,100
Pineapples	—	400	1,320	3,450	7,050	10,800
Plums and Prunes	550	1,450	2,200	2,700	4,700	10,900
Potatoes:						
Uncured	—	2,600	3,850	4,850	6,950	—
Cured	—	1,320	1,870	1,980	2,640	—
<sup>1</sup> Source: USDA Handbook No. 66. 1968, 1986, & 2016						
<sup>2</sup> To convert "Btu per ton per 24 hours" to "kcal per metric ton per 24 hours", multiply by 0.278.						

COMMODITY	BTU PER TON PER 24 HOURS <sup>2</sup>					
	32°F (0°C)	41°F (5°C)	50°F (10°C)	59°F (15°C)	68°F (20°C)	77°F (25°C)
Prunes (see plums)						
Radishes (topped)	3,520	4,400	7,480	16,280	28,600	37,840
Raspberries	3,740	5,600	7,700	9,240	27,500	—
Rhubarb (topped)	2,350	3,200	—	8,700	10,650	—
Romaine	—	4,550	9,750	—	15,100	23,850
Spinach	4,550	10,150	—	39,350	50,550	—
Squash:						
Butternut	—	—	—	—	—	20,650
Yellow straightneck	2,750	3,630	7,700	18,150	20,020	—
Strawberries	3,520	4,290	15,840	17,930	32,780	41,800
Sweetpotatoes:						
Cured	—	—	3,080	4,840	—	—
Uncured	—	—	—	6,380	—	13,970
Tomatoes:						
Mature-green	—	1,430	3,300	4,840	7,590	9,460
Pink	—	1,300	3,190	5,830	7,480	9,020
Turnips	1,900	2,150	3,520	5,000	5,400	—
Watercress	5,050	10,150	23,320	40,700	—	—
<sup>1</sup> Source: USDA Handbook No. 66. 1968, 1986, & 2016 <sup>2</sup> To convert "Btu per ton per 24 hours" to "kcal per metric ton per 24 hours", multiply by 0.278.						

**SAMPLE REFRIGERATION REQUIREMENT CALCULATION<sup>1</sup>**

Assume that a trailer is loaded with cucumbers in 30-pound fiberboard boxes:

Load = 1,200 boxes

Net wt. of cucumbers = 30 pounds per box

Total pounds = 36,000 pounds total (18 tons)

<sup>1</sup> This calculation does not take into account the following factors: (1) the amount of refrigeration needed to precool the vehicle body; (2) air inside the vehicle; and (3) refrigeration needed to counteract air leakage around doors and other places in the body. This calculation also does not include removal of field heat from commodities, because refrigerated transportation systems are not designed for that purpose.



Net wt. of boxes = 2 pounds each

Total pounds = 2,400 pounds total

Sp. ht. of the cucumbers = 0.97 Btu/lb/°F (Table I-1)

Sp. ht. box = 0.44 Btu/lb/°F<sup>2</sup>

### 1. Transit refrigeration requirement for the heat of respiration:

Assumptions:

Product loading and arrival temperatures = 50°F

then,

Average temperature of product during transit = 50°F.

Transit time = 3 days

then,

Heat of respiration (Hr) = Respiration rate at average transit temperature<sup>3</sup> X time (days) X wt. (tons)

Hr = 5,720 X 3 X 18 = 308,880 Btu<sup>3</sup>

### 2. Refrigeration needed for heat leakage through the trailer body:

Assumptions:

A 48-foot trailer with a Ua factor = 140 Btu/°F/hr.

Average outside air temperature = T1 = 75°F

Thermostat setting = T2 = 50°F<sup>4</sup>

Temperature differential = TD = T1 - T2 = 75°F - 50°F = 25°F

thus,

Heat leakage (Hl) = Ua X TD (avg. outside air - thermostat setting) X time (hours) = Btu

<sup>2</sup> This figure approximates the specific heat of most wood and fiberboard containers.

<sup>3</sup> See Table I-2, cucumbers at 50°F

<sup>4</sup> For products with a desired transport temperature near 32°F, the thermostat should be set somewhat higher to decrease the chance of freezing damage due to refrigeration cycling.

$$HI = 140 \times 25 \times 72 = 252,000 \text{ Btu}$$

**3. To get the total number of Btu's the refrigeration must remove in 3 days:**

$$Hr + HI = 308,880 + 252,000 = 560,880 \text{ Btu}$$

**4. To determine the amount of refrigeration or refrigerant needed:**

$$\text{Mechanical capacity needed} = 560,880 \text{ Btu} / 72 \text{ hrs} = 7,790 \text{ Btu hr}$$

$$\text{Ice} = \text{total pounds needed for 3-day trip} = 560,880 \text{ Btu} / 144^5 = 3,895 \text{ lb}$$

$$\begin{aligned} \text{Liquid nitrogen (N}_2\text{)} &= \text{total pounds needed for 3-day trip} = 560,880 \text{ Btu} / 175^6 \\ &= 3,205 \text{ lb} \end{aligned}$$

---

<sup>5</sup> One pound of ice will absorb 144 Btu of heat.

<sup>6</sup> One pound of liquid nitrogen will absorb approximately 175 Btu of heat at temperatures above 32°F

## Appendix II.

---

### LOAD COMPATIBILITY GROUPS<sup>1</sup>

#### Group 1

- Apples
- Apricots
- Berries (except cranberries)
- Cherries
- Figs (not with apples, danger of odor transfer to figs; also see Group 6a)
- Grapes<sup>2</sup> (see Groups 2 and 6a)
- Peaches
- Pears
- Persimmons
- Plums and prunes
- Pomegranates
- Quinces

#### ***Recommended Transit Conditions:***

- *Temperature:*  
32° to 34°F (0° to 1.5°C)
- *Relative humidity:*  
90 to 95 percent
- *Atmosphere:*  
Normally used on berries and cherries only — 10 to 20 percent CO<sub>2</sub>
- *Ice:*  
Never in contact with commodity.

**Note:** Most members of this group are not compatible with Group 6a or 6b because ethylene production by Group 1 can be high, and thus harmful to members of Group 6a or 6b.

#### Group 2

- Avocados
- Bananas

---

<sup>1</sup> Taken from USDA Marketing Research Report No. 1070, "Compatibility of Fruits and Vegetables During Transport in Mixed Loads," by W. J. Lipton and J. M. Harvey, 1977.

<sup>2</sup> Grapes: Compatible with other commodities only if the grapes are not fumigated with sulfur dioxide (SO<sub>2</sub>) in vehicle and if no chemicals that release SO<sub>2</sub> are included in packages.

- Eggplants (also see Group 5)
- Grapefruit<sup>3</sup>
- Guava
- Limes
- Mangoes
- Muskmelons, other than cantaloupes
  - Casaba
  - Crenshaw
  - Honey Dew
  - Persian
- Olives, fresh
- Papayas
- Pineapples (not with avocados, danger of avocados' odor absorption)
- Tomatoes, green
- Tomatoes, pink (also see Group 4)
- Watermelons (also see Groups 4 and 5)

***Recommended Transit Conditions:***

- *Temperature:*  
55° to 65°F (13° to 18°C)
- *Relative humidity:*  
85 to 95 percent
- *Ice:*  
Never in contact with commodity

**Group 3**

- Cantaloupes
- Cranberries
- Lemons (adjust temperature to other commodity)
- Lychees (also see Group 4)
- Oranges
- Tangerines

---

<sup>3</sup> Citrus Fruits: Oranges and tangerines — compatibility depends on source. Florida- or Texas-grown oranges are shipped at 32° to 34°F (0.0° to 1.1°C), but oranges grown in California and Arizona are shipped at 38° to 48°F (3.3° to 8.8° C).

**Recommended Transit Conditions:**

- *Temperature:*  
36° to 41°F (2.5° to 5.0°C)
- *Relative humidity:*  
90 to 95 percent; cantaloupes about 95 percent
- *Ice:*  
In contact only with cantaloupes

**Group 4**

- Beans, snap
- Lychees (also see Group 3)
- Okra
- Peppers, green (not with beans)
- Peppers, red (if with green peppers, temperature adjusted toward top of range)
- Squash, summer
- Tomatoes, pink (also see Group 2)
- Watermelons (also see Groups 2 and 5)

**Recommended Transit Conditions:**

- *Temperature:*  
40° to 45°F (4.5° to 7.5°C)
- *Relative humidity:*  
About 95 percent
- *Ice:*  
Never in contact with commodity

**Group 5**

- Cucumbers
- Eggplants (also see group 2)
- Ginger (not with eggplants, also see group 7)
- Grapefruit, Florida (after January 1), and Texas
- Potatoes (late crop)
- Pumpkin and squashes, winter
- Watermelons (temperature adjusted for other members of groups; also see Groups 2 and 4)

**Recommended Transit Conditions:**

- *Temperature:*  
40° to 55°F (4.4° to 13°C); ginger not below 55°F
- *Relative humidity:*  
85 to 90 percent
- *Ice:*  
Never in contact with commodity

**Group 6a**

- Artichokes
- Asparagus
- Beets, red
- Carrots
- Endive and escarole
- Figs (also see Group 1)
- Grapes (also see Group 1)
- Greens
- Leeks (not with figs or grapes)
- Lettuce
- Mushrooms
- Parsley
- Parsnips
- Peas
- Rhubarb
- Salsify
- Spinach
- Sweet corn
- Watercress

**Note:** This group, except for figs, grapes, and mushrooms, is compatible with Group 6b.

**Recommended Transit Conditions:**

- *Temperature:*  
32° to 34°F (0° to 1.1°C)
- *Relative humidity:*  
95 to 100 percent

- *Ice:*  
Never in contact with asparagus, figs, grapes, or mushrooms

### **Group 6b**

- Broccoli
- Brussels sprouts
- Cabbage
- Cauliflower
- Celeriac
- Horseradish
- Kohlrabi
- Onions, green (not with rhubarb, figs, grapes, mushrooms, or sweet corn)
- Radishes
- Rutabagas
- Turnips

**Note:** This group is compatible with Group 6a, except for figs, grapes, and mushrooms.

#### ***Recommended Transit Conditions:***

- *Temperature:*  
32° to 34°F (0° to 1.1°C)
- *Relative humidity:*  
95 to 100 percent
- *Ice:*  
Contact acceptable for all

### **Group 7**

- Ginger (also see Group 5)
- Potatoes, early crop (temperatures adjusted for others)
- Sweetpotatoes

#### ***Recommended Transit Conditions:***

- *Temperature:*  
55° to 65°F (13° to 18°C)
- *Relative humidity:*  
85 to 90 percent

- *Ice:*  
Never in contact with commodity

## **Group 8**

- Garlic
- Onions, dry

### ***Recommended Transit Conditions:***

- *Temperature:*  
32° to 34°F (0° to 1.5°C)
- *Relative humidity:*  
65 to 75 percent
- *Ice:*  
Never in contact with commodity



# Appendix III.

## RECOMMENDED PROTECTIVE SERVICES FOR PERISHABLE FOODS DURING TRANSIT

Table III-1. Recommended protective services for perishable foods during transit.

PRODUCT	RECOMMENDED TRANSIT TEMPERATURE		DESIRED RELATIVE HUMIDITY	HIGHEST FREEZING POINT		TOP ICE AND/OR PACKAGE ICE OK <sup>1</sup>
	°F	°C	PERCENT	°F	°C	YES/NO
Fresh Fruits and Vegetables:						
Apples (depending on variety)	30 to 40	-1.1 to 4.4	90 - 95	30.0	-1.1	No
Apricots	32	0.0	90 - 95	30.1	-1.1	No
Artichokes (globe)	32	0.0	95 - 100	29.9	-1.2	Yes
Asparagus	32 to 35	to 1.7	95 - 100	30.9	-0.6	No
Avocados:						
Cold-tolerant varieties	40	4.4	85 - 90	31.5	-0.3	No
Cold-intolerant varieties	55	12.8	85 - 90	31.5	-0.3	No
Bananas	56 to 58	13.3 to 14.4	90 - 95	30.6	-0.8	No
Beans:						
Green or snap	40 to 45	4.4 to 7.2	95	30.7	-0.7	No
Lima, in pods	37 to 41	2.8 to 5.0	95	31.0	-0.6	No
Beets	32	0.0	98 - 100	30.3	-0.9	Yes

<sup>1</sup> Make sure products are packed in moisture resistant containers before applying top ice or package ice.  
<sup>2</sup> Florida and Texas oranges shipped from cold storage or those that will be in transit for more than 5 days should be held at 32° to 34°F (0° to 1°C). Arizona and California oranges should be shipped at 38° to 48°F (3° to 9°C).  
<sup>3</sup> Early Bartlett pears that are ripened in transit should be shipped at 55° to 60°F (12.8° to 15.6°C).  
<sup>4</sup> See text page 153 and Table 7.  
<sup>5</sup> See text page 156 and Table 8.  
<sup>6</sup> See text page 162 and Table 10.  
<sup>7</sup> All frozen foods should be shipped at 0°F (-18°C) or below.

PRODUCT	RECOMMENDED TRANSIT TEMPERATURE		DESIRED RELATIVE HUMIDITY	HIGHEST FREEZING POINT		TOP ICE AND/OR PACKAGE ICE OK <sup>1</sup>
	°F	°C	PERCENT	°F	°C	YES/NO
Beet tops	32	0.0	95 - 100	31.3	-0.4	Yes
Blackberries	31 to 32	-0.6 to 0.0	90 - 95	30.5	-0.8	No
Blueberries	31 to 32	-0.6 to 0.0	90 - 95	29.7	-1.3	No
Broccoli	32	0.0	95 - 100	30.9	-0.6	Yes
Cabbage	32	0.0	98 - 100	30.4	-0.9	Yes
Cantaloupes	36 to 41	2.2 to 5.0	95	29.9	-1.2	Yes
Carrots	32	0.0	98 - 100	29.5	-1.4	Yes
Cauliflower	32	0.0	90 - 98	30.6	-0.8	Yes
Celery	32	0.0	98 - 100	31.1	-0.5	Yes
<b>Cherries:</b>						
Sweet	30 to 31	-1.1 to -0.6	90 - 95	28.8	-1.8	No
Sour	32	0.0	90 - 95	29.0	-1.7	No
Corn (sweet)	32	0.0	95 - 98	30.9	-0.6	Yes
Cranberries	36 to 40	2.2 to 4.4	90 - 95	30.4	-0.9	No
Cucumbers	50 to 55	10.0 to 12.8	95	31.1	-0.5	No
Eggplants	46 to 54	8.0 to 12.2	90 to 95	30.6	-0.8	No
Endive (escarole)	32	0.0	90 to 95	31.9	-0.1	Yes
<p><sup>1</sup> Make sure products are packed in moisture resistant containers before applying top ice or package ice.</p> <p><sup>2</sup> Florida and Texas oranges shipped from cold storage or those that will be in transit for more than 5 days should be held at 32° to 34°F (0° to 1°C). Arizona and California oranges should be shipped at 38° to 48°F (3° to 9°C).</p> <p><sup>3</sup> Early Bartlett pears that are ripened in transit should be shipped at 55° to 60°F (12.8° to 15.6°C).</p> <p><sup>4</sup> See text page 153 and Table 7.</p> <p><sup>5</sup> See text page 156 and Table 8.</p> <p><sup>6</sup> See text page 162 and Table 10.</p> <p><sup>7</sup> All frozen foods should be shipped at 0°F (-18°C) or below.</p>						

PRODUCT	RECOMMENDED TRANSIT TEMPERATURE		DESIRED RELATIVE HUMIDITY	HIGHEST FREEZING POINT		TOP ICE AND/OR PACKAGE ICE OK <sup>1</sup>
	°F	°C	PERCENT	°F	°C	YES/NO
Garlic (dry)	32 to 34	0.0 to 1.1	65 to 75	30.5	-0.8	No
Grapefruit:						
Arizona and California	58 to 60	14.0 to 15.6	85 to 90	30.0	-1.1	No
Florida and Texas	50 to 60	10.0 to 15.6	85 to 90	30.0	-1.1	No
Grapes:						
American type	32	0.0	85	29.7	-1.3	No
European type (vinifera)	30 to 31	-1.1 to -0.6	90 to 95	28.1	-2.2	No
Kale	32	0.0	95 to 100	31.1	-0.5	Yes
Kiwifruit	32	0.0	90 to 95	29.0	-1.7	No
Lemons	45 to 55	7.2 to 12.8	85 to 90	29.4	-1.4	No
Lettuce	32	0.0	98 to 100	31.7	-0.2	No
Limes	48 to 50	8.9 to 10.0	85 to 90	29.1	-1.6	No
Mangoes	55	12.8	85 to 90	30.3	-0.9	No
Melons: Honeydew, Casa- ba, Crenshaw, and Persian	45 to 50	7.2 to 10.0	90 to 95	30.5	-0.8	No
Mushrooms	32	0.0	95	30.4	-0.9	No

<sup>1</sup> Make sure products are packed in moisture resistant containers before applying top ice or package ice.  
<sup>2</sup> Florida and Texas oranges shipped from cold storage or those that will be in transit for more than 5 days should be held at 32° to 34°F (0° to 1°C). Arizona and California oranges should be shipped at 38° to 48°F (3° to 9°C).  
<sup>3</sup> Early Bartlett pears that are ripened in transit should be shipped at 55° to 60°F (12.8° to 15.6°C).  
<sup>4</sup> See text page 153 and Table 7.  
<sup>5</sup> See text page 156 and Table 8.  
<sup>6</sup> See text page 162 and Table 10.  
<sup>7</sup> All frozen foods should be shipped at 0°F (-18°C) or below.

PRODUCT	RECOMMENDED TRANSIT TEMPERATURE		DESIRED RELATIVE HUMIDITY	HIGHEST FREEZING POINT		TOP ICE AND/OR PACKAGE ICE OK <sup>1</sup>
	°F	°C	PERCENT	°F	°C	YES/NO
Okra	45 to 50	7.2 to 10.0	90 to 95	28.7	-1.8	No
Onions:						
Dry	32	0.0	65 to 70	30.6	-0.8	No
Green	32	0.0	95 to 100	30.4	-0.9	Yes
Shallots	32	0.0	95 to 100	31.6	-0.2	Yes
Leeks	32	0.0	95 to 100	30.7	-0.7	Yes
Oranges <sup>2</sup>	32 to 48	0.0 to 8.8	85 to 90	30.6	-0.8	No
				(flesh)		
				29.7	-1.3	
				(peel)		
Parsley	32	0.0	95 to 100	30.0	-1.1	Yes
Parsnips	32	0.0	98 to 100	30.4	-0.9	Yes
Peaches and Nectarines	31 to 32	-0.6 to 0.0	90 to 95	30.4	-0.9	No
Pears <sup>3</sup>						
Peas:						
Green, in pods	32	0.0	95 to 98	30.9	-0.6	Yes
Shelled	32	0.0	95 to 98	29.9	-1.2	Yes
Peppers (sweet)	45 to 55	7.2 to 12.8	90 to 95	30.7	-0.7	No

<sup>1</sup> Make sure products are packed in moisture resistant containers before applying top ice or package ice.  
<sup>2</sup> Florida and Texas oranges shipped from cold storage or those that will be in transit for more than 5 days should be held at 32° to 34°F (0° to 1°C). Arizona and California oranges should be shipped at 38° to 48°F (3° to 9°C).  
<sup>3</sup> Early Bartlett pears that are ripened in transit should be shipped at 55° to 60°F (12.8° to 15.6°C).  
<sup>4</sup> See text page 153 and Table 7.  
<sup>5</sup> See text page 156 and Table 8.  
<sup>6</sup> See text page 162 and Table 10.  
<sup>7</sup> All frozen foods should be shipped at 0°F (-18°C) or below.

PRODUCT	RECOMMENDED TRANSIT TEMPERATURE		DESIRED RELATIVE HUMIDITY	HIGHEST FREEZING POINT		TOP ICE AND/OR PACKAGE ICE OK <sup>1</sup>
	°F	°C	PERCENT	°F	°C	YES/NO
Pineapples:						
Mature-green	50 to 55	10.0 to 13.0	85 to 90	30.0	-1.1	No
Ripe	45	7.2	85 to 90	30.0	-1.1	No
Plums and Prunes	32	0.0	90 to 95	30.5	-0.8	No
Potatoes:						
Early crop for table	50 to 60	10.0 to 15.6	90	30.9	-0.6	No
Early crop for chipping	65 to 70	18.3 to 21.1	90	30.9	-0.6	No
Late crop for table	40 to 50	4.4 to 10.0	90	30.9	-0.6	No
Late crop for chipping	50 to 60	10.0 to 15.6	90	30.9	-0.6	No
Radishes	32	0.0	95 to 100	30.7	-0.7	Yes
Raspberries	32	0.0	90 to 95	30.0	-1.1	No
				(black)		
				30.9	-0.6	
				(red)		
Rhubarb	32	0.0	95 to 100	30.3	-0.9	No
Romaine	32	0.0	95	31.7	-0.2	Yes
Salad mixes	33	0.6	90 to 95	(varies)		No
Spinach	32	0.0	95 to 100	31.5	-0.3	Yes

<sup>1</sup> Make sure products are packed in moisture resistant containers before applying top ice or package ice.  
<sup>2</sup> Florida and Texas oranges shipped from cold storage or those that will be in transit for more than 5 days should be held at 32° to 34°F (0° to 1°C). Arizona and California oranges should be shipped at 38° to 48°F (3° to 9°C).  
<sup>3</sup> Early Bartlett pears that are ripened in transit should be shipped at 55° to 60°F (12.8° to 15.6°C).  
<sup>4</sup> See text page 153 and Table 7.  
<sup>5</sup> See text page 156 and Table 8.  
<sup>6</sup> See text page 162 and Table 10.  
<sup>7</sup> All frozen foods should be shipped at 0°F (-18°C) or below.

PRODUCT	RECOMMENDED TRANSIT TEMPERATURE		DESIRED RELATIVE HUMIDITY	HIGHEST FREEZING POINT		TOP ICE AND/OR PACKAGE ICE OK <sup>1</sup>
	°F	°C	PERCENT	°F	°C	YES/NO
Squash and pumpkins:						
Winter	50 to 55	10.0 to 12.8	50 to 70	30.5	-0.8	No
Summer	41 to 50	5.0 to 10.0	95	31.1	-0.5	No
Strawberries	32	0.0	90 to 95	30.6	-0.8	No
Sweetpotatoes	55 to 60	12.8 to 15.6	85 to 90	29.7	-1.3	No
Tangerines	40	4.4	90 to 95	30.1	-1.1	No
Tomatoes:						
Mature-green	55 to 70	12.8 to 21.1	90 to 95	31.0	-0.6	No
Pink (vine-ripe)	46 to 50	7.2 to 10.0	90 to 95	31.1	-0.5	No
Watermelons	50 to 60	10.0 to 15.6	90	31.3	-0.4	No
Canned Foods <sup>4</sup>	—	—	—	—	—	—
Dairy Products:						
Butter:						
Fresh	39	3.9	75 to 85			No
Frozen	-10	-23.3				No
Margarine	35	1.7	60 to 70			No
Milk (whole)	32 to 34	0.0 to 1.1	— — — —	31.0	-0.6	No
<p><sup>1</sup> Make sure products are packed in moisture resistant containers before applying top ice or package ice.</p> <p><sup>2</sup> Florida and Texas oranges shipped from cold storage or those that will be in transit for more than 5 days should be held at 32° to 34°F (0° to 1°C). Arizona and California oranges should be shipped at 38° to 48°F (3° to 9°C).</p> <p><sup>3</sup> Early Bartlett pears that are ripened in transit should be shipped at 55° to 60°F (12.8° to 15.6°C).</p> <p><sup>4</sup> See text page 153 and Table 7.</p> <p><sup>5</sup> See text page 156 and Table 8.</p> <p><sup>6</sup> See text page 162 and Table 10.</p> <p><sup>7</sup> All frozen foods should be shipped at 0°F (-18°C) or below.</p>						

PRODUCT	RECOMMENDED TRANSIT TEMPERATURE		DESIRED RELATIVE HUMIDITY	HIGHEST FREEZING POINT		TOP ICE AND/OR PACKAGE ICE OK <sup>1</sup>
	°F	°C	PERCENT	°F	°C	YES/NO
Cheese <sup>5</sup>	34 to 40	1.0 to 4.0	65 to 70			No
Ice Cream	-20 to -15	-29 to -26	— — — —	21.0	-6.0	No
Fresh and Cured Meat and Seafood <sup>6</sup>	—	—	—	—	—	—
Frozen Foods <sup>7</sup>	—	—	—	—	—	—
<b>Poultry and Eggs:</b>						
Fresh	26 to 34	-3.0 to 1.1	90 to 95	27.0	-2.8	Yes
Hard, chilled	0 to 26	-18 to -3	90 to 95	27.0	-2.8	No
Eggs	40 to 45	4.4 to 7.2	80 to 85	28.0	-2.2	No

<sup>1</sup> Make sure products are packed in moisture resistant containers before applying top ice or package ice.  
<sup>2</sup> Florida and Texas oranges shipped from cold storage or those that will be in transit for more than 5 days should be held at 32° to 34°F (0° to 1°C). Arizona and California oranges should be shipped at 38° to 48°F (3° to 9°C).  
<sup>3</sup> Early Bartlett pears that are ripened in transit should be shipped at 55° to 60°F (12.8° to 15.6°C).  
<sup>4</sup> See text page 153 and Table 7.  
<sup>5</sup> See text page 156 and Table 8.  
<sup>6</sup> See text page 162 and Table 10.  
<sup>7</sup> All frozen foods should be shipped at 0°F (-18°C) or below.

# Appendix IV.

## SANITARY TRANSPORTATION OF FOOD – COMPLIANCE CHECKLIST

<b>Sanitary Transportation of Food – Compliance Checklist</b>												
Sub Section	Best Practice Section	Synopsis of Regulatory Requirement	Sector									
			Shipper/ Broker		Loader		Carrier		Receiver			
Matrix Key:			Sector Scope:		Responsibility:		I		V			
			Refrigerated transport of perishable food, within the context of this document, applies to the use of Refrigerated Truck Trailers, Refrigerated Truck Bodies and Multi-Temperature Trailers. This document does not apply to rail, air or ocean transport.									
			I		This sector has <b>PRIMARY</b> responsibility for understanding and <b>IMPLEMENTING</b> the industry Best Practice and/or regulatory requirement to achieve regulatory compliance.							
			V		This sector should understand the industry Best Practice and/or regulatory requirement and has <b>SECONDARY</b> responsibility for <b>VERIFYING</b> that compliance was met by others in the integrated cold chain.							
			I	V	I	V	I	V	I	V		
1.906a	3.1	Appropriate vehicle and transportation equipment design for sanitary food transport	✓			✓	✓			✓		
1.906b	3.1	Appropriate equipment maintenance for sanitary food transport	✓			✓	✓			✓		
1.906c	3.1	Vehicles and transportation equipment properly designed, maintained and equipped for sanitary food transport	✓			✓	✓			✓		
1.906d	3.2	Proper storage of vehicles and transportation equipment when not in use	✓			✓	✓		✓			
1.908a	2.2	Competent supervisory personnel	✓		✓		✓		✓			
	3.3	Transportation operations conducted in a safe manner	✓		✓		✓		✓			
	3.4	Transportation parameters specified	✓			✓		✓		✓		
	3.3	Written food safety procedures in place	✓		✓		✓		✓			
	3.4											
	3.5	Food safety checks if a temperature deviation occurs							✓			
1.908b	3.8	Shipper provides written sanitary specifications to other parties	✓			✓		✓		✓		
	3.3	Shipper establishes and provides written notice of temperature parameters to all parties	✓			✓		✓		✓		
	3.4											
	3.8	Shipper develops and implements written procedures for vehicle sanitation	✓			✓		✓		✓		
	4.0											
14.3	3.7	Shippers of bulk foods develop and implement written procedures for the sanitary transportation of refrigerated foodstuffs	✓			✓		✓		✓		
	3.3	Shipper develops and implements written procedures for the sanitary transportation of refrigerated foodstuffs	✓			✓		✓		✓		
	3.4											
1.908c	3.8	Loaders to verify the sanitary condition of transportation equipment		✓	✓			✓		✓		
	5.0	Loaders to verify the proper operating condition of transportation equipment		✓	✓			✓		✓		
14.3												
1.908d	11.0	Receivers to assess inbound food for temperature abuse in transit or off condition		✓	✓			✓		✓		
	14.10											



Sanitary Transportation of Food – Compliance Checklist										
Matrix Key:			Sector Scope:	Refrigerated transport of perishable food, within the context of this document, applies to the use of Refrigerated Truck Trailers, Refrigerated Truck Bodies and Multi-Temperature Trailers. This document does not apply to rail, air or ocean transport.						
			Responsibility:	I	This sector has <b>PRIMARY</b> responsibility for understanding and <b>IMPLEMENTING</b> the industry Best Practice and/or regulatory requirement to achieve regulatory compliance.					
V	This sector should understand the industry Best Practice and/or regulatory requirement and has <b>SECONDARY</b> responsibility for <b>VERIFYING</b> that compliance was met by others in the integrated cold chain.									
Sub Section	Best Practice Section	Synopsis of Regulatory Requirement	Sector							
			Shipper/ Broker		Loader		Carrier		Receiver	
			I	V	I	V	I	V	I	V
1.908e	5.0	Carrier to ensure that vehicles and equipment meet shippers specifications		✓		✓	✓			✓
	3.3 3.4	Carrier to provide the operating temperature specified by the shipper and be prepared to demonstrate compliance with specifications		✓		✓	✓			✓
	6.0	Carrier to pre-cool mechanically refrigerated storage compartments as per shipper specifications		✓		✓	✓			✓
	3.7	Carrier to identify previous cargo transported in bulk vehicle if requested by shipper		✓		✓	✓			✓
	3.7	Carrier to provide information about the most recent cleaning of a bulk vehicle if requested by shipper		✓		✓	✓			✓
	3.8 14.6	Carrier to develop and implement written cleaning, sanitizing and inspection procedures		✓		✓	✓			✓
	4.0	Carrier to develop and implement written procedures describing compliance with temperature control requirements		✓		✓	✓			✓
	3.7	Carrier to develop and implement written procedures describing compliance with bulk vehicle requirements		✓		✓	✓			✓
1.910	2.0	Carrier to establish and maintain training records		✓		✓	✓			✓
1.912a	12.0	Shipper to retain records, written procedures and agreements for 12 months beyond termination of agreement or when procedures are in use	✓							
1.912b	12.0	Carrier to retain records, written procedures and agreements for 12 months beyond when the agreements and procedures are in use					✓			
1.912c	12.0	Carrier to retain training records for 12 months beyond when the person identified in records continues to perform the duties for which they were trained	✓				✓			
1.912d	12.0	Persons subject to STF Rule to retain written agreements assigning tasks covered by the rule for 12 months beyond the termination of the agreement	✓		✓		✓			✓
1.912e	12.0	Covered parties operating under ownership or control of a single legal entity to retain records of their written procedures for 12 months beyond when the procedures are in use	✓		✓		✓			✓
1.912f	12.0	Covered parties to make all records available to duly authorized individuals upon request	✓		✓		✓			✓
1.912g	12.0	Records to be maintained as original, true copies or electronic records	✓		✓		✓			✓

Source: International Refrigerated Transportation Association.

# Appendix V.

## REEFER CONTAINER LOADING AND DEVANNING CHECK LISTS

### Reefer Container Loading Check List

Shipper \_\_\_\_\_ Temperature Setting (°F) \_\_\_\_\_  
 Commodity \_\_\_\_\_ Air Exchange (cfm or cmh) \_\_\_\_\_  
 Transportation Carrier \_\_\_\_\_ Carton Count \_\_\_\_\_  
 Container ID \_\_\_\_\_ Pulp Temperatures (°F) \_\_\_\_\_  
 B/L# \_\_\_\_\_ Security Seal # \_\_\_\_\_  
 Temp. Recorder # (s) \_\_\_\_\_ CA Setting \_\_\_\_\_

Container Check List	Yes(✓)	No (✓)	
Container Precooled to Carrying Temperature			
Partlow Chart Attached			
Microprocessor Reefer Unit			
Portable Temperature Recorder(s)			
MGset Attached (Nose or Belly Mount)			
Thermostat Setting Correct			
Fresh Air Exchange Correct			
Hand stow			
Palletized			
Container Condition	Okay (✓)	Problem (✓)	Describe Problem
Interior Cleanliness			
Interior Odor			
Damage			
Rear Doors			
Door Seals			
Floor Drains & Kazoos			
Reefer Unit Operational			
MGset Unit Operational			
Adequate MGset Fuel			
Photos (attach photo exhibits)			
Loading Pattern (attach diagram)			

Inspector Signature \_\_\_\_\_  
 Driver Signature \_\_\_\_\_

Source: PEB Commodities, Inc.

## Reefer Container Devanning Check List

Shipper \_\_\_\_\_ Temperature Setting (°F) \_\_\_\_\_  
 Commodity(s) \_\_\_\_\_ Vent Setting (cfm or cmh) \_\_\_\_\_  
 Vessel Voyage \_\_\_\_\_ CA Setting \_\_\_\_\_  
 Transportation Carrier \_\_\_\_\_ Carton (package) Count \_\_\_\_\_  
 Container ID \_\_\_\_\_ Pulp Temps (°F or °C) \_\_\_\_\_  
 Truckers B/L# \_\_\_\_\_ Security Seal # \_\_\_\_\_  
 Reefer Unit mfg. \_\_\_\_\_ Temp. Recorder(s) ID 1 \_\_\_\_\_  
 ID 2 \_\_\_\_\_  
 ID 3 \_\_\_\_\_

Container Check List	Yes (✓)	No (✓)	
Hand stow			
Palletized			
Stowage above red line			
MGset Attached (Nose or Belly Mount)			
Container Condition	Okay(✓)	Problem(✓)	Describe Problem(s)
Interior Cleanliness			
Interior Odor			
Container Condition (damage)			
Door Seals			
Floor Drains & Kazoos			
Reefer Unit Operational			
MGset Unit Operational			
Photos (attach photo exhibits)			
Loading Pattern (attach diagram)			

Inspector Signature \_\_\_\_\_

Date \_\_\_\_\_

Source: PEB Commodities, Inc.

## Selected Bibliography

---

American Frozen Food Institute. 2009. *Frozen Food Handling and Merchandising*. Arlington, VA.

American Society of Heating, Refrigerating, and Air-Conditioning Engineers. 2018. *ASHRAE Handbook — Refrigeration*. Atlanta, GA.

Brecht, P.E., D. Durm, and L. Rodowick. 2016. *Refrigerated Transportation Best Practices Guide*. International Refrigerated Transportation Association.

Brecht, P.E., D. Durm, and L. Rodowick. 2016. *Summary & User Guide: FDA's Sanitary Transportation of Food Final Rule Advancing the Sanitary Transportation of Human and Animal Food*. International Refrigerated Transportation Association.

Brecht, P.E., D. Durm, and L. Rodowick. 2016. *Sanitary Transportation of Food Compliance Matrix*. International Refrigerated Transportation Association.

Gross, K.C., C.Y. Wang, and M. Saltveit. 2016. *The Commercial Storage of Fruits, Vegetables, and Florist and Nursery Stocks*. Agricultural Handbook No. 66, ARS, U.S. Department of Agriculture, Washington, DC. <https://www.ars.usda.gov/is/np/CommercialStorage/CommercialStorage.pdf>

McGregor, B.M. 1987. *Tropical Products Transport Handbook*. Agricultural Handbook No. 668, AMS, U.S. Department of Agriculture, Washington, DC. <https://www.ams.usda.gov/sites/default/files/media/Tropical%20Products%20Transport%20Handbook.pdf>

Thompson, J.F., P.E. Brecht, T. Hinsch, and A.A. Kader. 2000. *Marine Container Transport of Chilled Perishable Products*. University of California Div. of Agricultural & Natural Resources. Pub. No. 21595.

Thompson, J.F., P.E. Brecht, and T. Hinsch. 2002. *Refrigerated Trailer Transport of Perishable Products*. University of California Div. of Agricultural & Natural Resources. Pub. No. 21614.

Welby, E.M. and B. McGregor. 2004. *Agricultural Export Transportation Handbook*. Agricultural Handbook No. 700, AMS, U.S. Department of Agriculture, Washington, DC. <https://www.ams.usda.gov/sites/default/files/media/Agricultural%20Export%20Transportation%20Handbook.pdf>

World Food Logistics Organization. 2018. *Commodity Storage Manual*. Alexandria, VA

## Other Resources

---

Thompson, J.F., P.E. Brecht, and T. Hinsch. 2002. *Loading Refrigerated Trailers*. University of California Div. of Agricultural & Natural Resources. Pub. No. 21615. (poster)

Thompson, J.F., P.E. Brecht, T. Hinsch, and C.H. Crisosto. 2000. *Instrucciones para Estibar un Contenedor Maritimo*. University of California Div. of Agricultural & Natural Resources. Pub. No. 21596-S. (poster)

Thompson, J.F., P.E. Brecht, T. Hinsch, and C.H. Crisosto. 2002. *Instrucciones para Cargar Camiones Frigorificos*. University of California Div. of Agricultural & Natural Resources. Pub. No. 21615-S. (poster)

Thompson, J.F., P.E. Brecht, T. Hinsch, and A.A. Kader. 2000. *Loading Marine Containers*. University of California Div. of Agricultural & Natural Resources. Pub. No. 21596. (poster)

Transfresh Corp. 1988. Fresh Produce Mixer & Loading Guide. Salinas, CA. (slide chart) <http://www.transfresh.com/resources/mixer-guide>

