

Award Lecture

SEMICONDUCTOR CHEMICAL REACTOR ENGINEERING

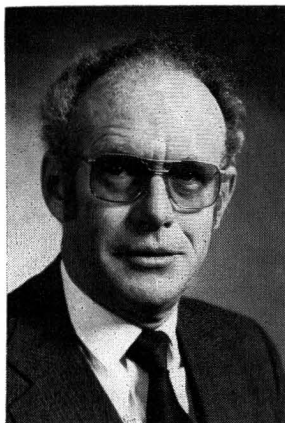

The Chemical Engineering Division Award Lecturer for 1984 is T. W. Fraser Russell. The 3M Company provides financial support for this annual lectureship award. The lecture has been presented at the University of Florida, the University of Michigan, and Colorado School of Mines.

A native of Moose Jaw, Canada, Fraser Russell received his BSc and MSc in chemical engineering from the University of Alberta and his PhD from the University

of Delaware. He joined the department at Delaware in 1964 and is presently the Allan P. Colburn Professor of Chemical Engineering.

Prior to beginning his academic career, he spent two years with the Research Council of Alberta, where he did early development work with the Athabasca Tar Sands. He later joined Union Carbide Canada as a design engineer, where he completed the reactor and process design for all of Union Carbide's ethylene oxide derived chemicals. His innovative process design for these oxide derivative units became the first multi-purpose continuous processing unit built in Canada.

In research, Russell's efforts have been directed into two major areas: design of gas-liquid systems; and semiconductor chemical reaction engineering and photovoltaic unit operations. His research in gas-liquid system design has resulted in over 25 publications which have been widely used by industrial concerns and have led to improved design of gas-liquid contactors and reactors and biological waste treatment systems.

Russell is recognized as a respected and inspiring teacher and has received the University of Delaware's Excellence in Teaching Award. His efforts in education have resulted in the publication of two texts, *Introduction to Chemical Engineering Analysis with Morton M. Denn*, and *The Structure of the Chemical Process Industries with J. Wei and M. Swartzlander*.

In the research and development of thin-film photovoltaic cells, his efforts have centered on the need to apply chemical reaction engineering principles to improve the design and operation of reactors used in making the semiconductor material, and to ensure that solar cells developed at the laboratory scale can be manufactured in commercial quantities. He carries out this research as Director of the Institute of Energy Conversion, a laboratory with a staff of some fifty people devoted to the development of thin-film photovoltaic cells.

T. W. F. RUSSELL
Institute of Energy Conversion
University of Delaware
Newark, DE 19716

THE QUANTITATIVE ANALYSIS of a reactor producing semiconductor film can be termed semiconductor chemical reactor engineering if the analysis creates procedures which improve the design, operation, and product quality of laboratory or larger scale reactors. The creation of a thin-film semiconductor, or indeed any thin film, requires an understanding of both molecular and transport phenomena. The process is analogous to that encountered in a typical catalytic reacting system (Fig. 1). Molecules must reach the surface of a substrate, adsorb on the substrate, diffuse and/or react on the substrate to produce a film possessing specified material and electronic properties. In a catalytic system, the product desorbs, leaving the substrate for the surrounding fluid phase.

A variety of reactors have been employed to move molecules or atoms to the substrate but much can be learned by considering two general types:

- Physical vapor deposition reactors
- Chemical vapor deposition reactors

In a physical vapor deposition reactor the required solid or liquid phase species are placed in a source. Energy is supplied to vaporize these species causing molecular beams to impinge on the substrate [1].

In a chemical vapor deposition reactor the molecular species are continuously supplied in a vapor phase which flows over the substrate. A

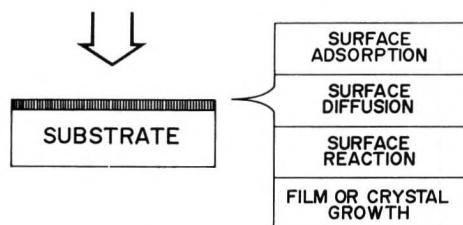

FIGURE 1. Surface molecular phenomena.

AND PHOTOVOLTAIC UNIT OPERATIONS

quantitative understanding of transfer from the bulk vapor to the surface is required and it may be necessary to contend with complex reactions in the vapor phase [2].

The performance of a reactor which produces a semiconductor film is judged by the quality of the film produced. Much effort is being devoted to ascertaining film quality by measuring optical and

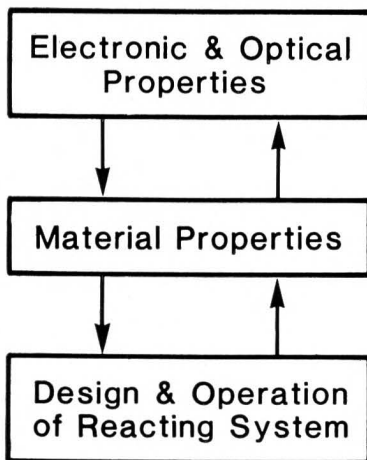

FIGURE 2. Simplified logic diagram.

electronic properties but film quality is ultimately determined by the performance of the semiconductor in some type of electronic device. A successful semiconductor chemical reaction and reactor analysis should provide experimentally verified models linking the electronic properties of the film to the design and operation of the reactor through a detailed understanding of the material properties of the film and the mechanism of film growth (Fig. 2).

The logical sequence summarized in Fig. 2 has been followed by the integrated silicon circuit community of researchers and industrial practitioners in dealing with the key step in integrated circuit manufacture of dopant diffusion into a film. It has not been a trivial task and well over two decades of effort have gone into the development of models relating device performance to doping concentration profile and doping concentration profile to the design and operation of the furnace [3]. Growing a polycrystalline or amorphous film, predictably,

with the desired electronic properties is an even more difficult task; one which remains an active integrated circuit research area today.

If one is interested in applications which could require millions of square meters per year of semiconductor film, the task of effectively predicting film growth becomes an order of magnitude more complex. Semiconductor films covering an area on the order of a square meter or more are needed for

- photovoltaic panels for power generation
- electro-photography
- electronic devices for thin-film displays

For these large-area applications it is necessary to carry out research on a scale between that used in a typical laboratory and that required for commercial operations. This unit operations scale research needs to have both a theoretical and experimental component which builds upon the laboratory scale research. The position of chemical reactor engineering and unit operations scale experimentation in the research logic is shown in Fig. 3.

I will illustrate the application of semiconductor chemical reactor engineering with research we have underway in physical vapor deposition of CdS at both the laboratory and unit operations

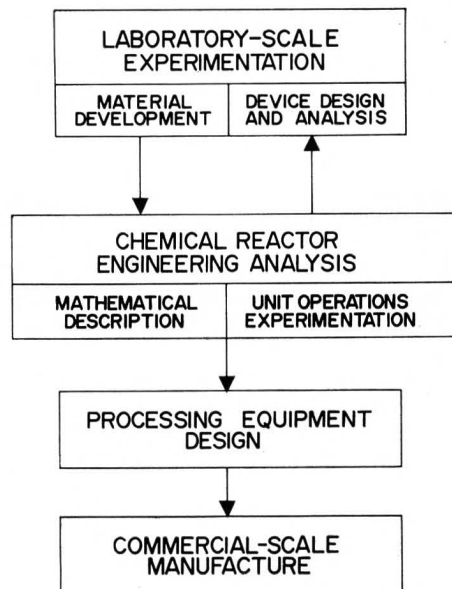

FIGURE 3. Role of chemical reactor analysis.

We originally became interested in the semi-conductor research because of a need to design larger scale reacting systems. However, the last five years of research has taught us that the chemical engineering analysis is very useful in the laboratory scale research effort, and indeed essential, if such research is to be done efficiently and with minimum expense (a key issue with today's research costs).

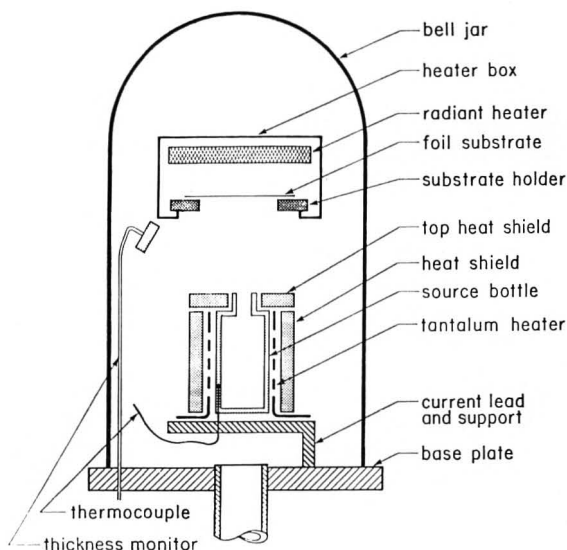

FIGURE 4. Physical vapor deposition reactor.

scale and chemical vapor deposition of amorphous silicon at the laboratory scale.

PHYSICAL VAPOR DEPOSITION

Laboratory Scale Research

A typical laboratory scale physical vapor deposition unit is shown in Fig. 4. The rate of evaporation of any material is determined by the surface temperature of the source material. For thermal evaporation this is a function of bottle geometry, the material surface area, and the design of the source heater. To make a semiconductor film, the material of interest is placed in the source bottle, heated to the point at which it evaporates or sublimates, flows out of the source bottle to the sub-

$$\frac{\partial \rho V}{\partial t} = \rho_g q$$

$$\rho V C_p \frac{\partial T_1}{\partial t} = -\rho_g q \Delta H_R + F_V E \sigma (T_2^4 - T_1^4) A_s$$

FIGURE 5. Model equations.

strate, and then condenses on the substrate, the temperature of which is carefully controlled.

The modeling and experimental verification of a model describing the rate of effusion for CdS which dissociates and sublimates has been thoroughly discussed by Rocheleau et al [4]. The mass and energy balance equations written for the material to be evaporated are shown in Fig. 5 (nomenclature in [4]). These equations can be solved numerically, given the initial dimensions of the material in the source bottle and the appropriate constitutive equations for the flow through the orifice in the source bottle. Fig. 6 gives the required equations in terms of the mass flux, r , related to

FLOW REGIME	ORIFICE	PIPE
Free Molecular ($\lambda_m/R > 1$)	$r = (\rho_1 q_c / 2\pi)^{1/2} (p_1 - p_2)$	$r = \frac{q_c R^2 p_1}{16\mu L} (p_1^2 - p_2^2) \left[4 \left(\frac{2}{f} - 1 \right) \frac{\lambda_m}{R} \right]$
Viscous ($\lambda_m/R < 0.01$)	$r = C_0 \sqrt{[2\rho q_c (p_1 - p_2)]^{1/2}}$	$r = \frac{q_c R^2 p_1}{16\mu L} (p_1^2 - p_2^2)$

FIGURE 6. Constitutive flow equations.

$\rho_g q$ through the area available for flow. The solution method is somewhat complex and complete details are given by Rocheleau et al [4] and Rocheleau [6]. Solving the equations yields the rate of effusion versus charge temperature, T_1 . A comparison of model prediction (solid lines) and experimental data (horizontal bars marked with the wall temperature, T_2) are shown for two different orifices in Fig. 7. The heat transfer from the source bottle walls to the subliming surface is the key issue in predicting rate of effusion from the source bottle.

Another type of experiment in which cadmium and sulfur are used in separate source bottles can be used to obtain information on the surface phenomena (Fig. 1). An extensive set of data has been obtained by Jackson [5] who also was able to predict the impingement rate of the molecular beam at any point on the substrate. The impingement rate of cadmium and sulfur on the substrate was calculated and the corresponding rate of CdS film

growth measured. About 1000 separate pieces of data were obtained to verify the predicted model behavior. The model equations for each species are shown in Fig. 8. The rate of reaction of cadmium to the CdS comprising the film is assumed to be

$$r(\text{rxt, Cd}) = k(\text{CdS}) [\text{Cd}^*][\text{S}^*]$$

This expression combined with the equations shown in Fig. 8 yields

$$r(\text{rxt, Cd}) = K(\text{CdS}) [\delta(\text{Cd}) r(\text{i, Cd}) - r(\text{rxt, Cd})] [\delta(\text{S}) r(\text{i, S}) - r(\text{rxt, S})]$$

The parameter, δ , is a condensation coefficient; $r(\text{i, Cd or S})$ is the rate of molecular impingement of Cd or S; $r(\text{rxt, Cd or S})$ is the rate of reaction of Cd or S; and K is a modified specific reaction rate constant whose detailed form is given by Jackson [5].

Comparison of the model behavior with some of the data is shown as Fig. 9 where the rate of deposition of CdS is plotted as a function of the

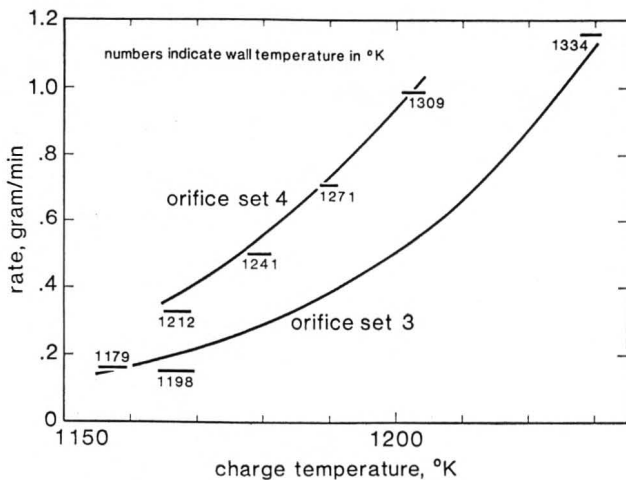

FIGURE 7. Comparison of model behavior with experimental data.

rate at which cadmium is delivered to the substrate. At low values of $r(\text{i, Cd})$ the rate of film growth is proportional to the rate at which cadmium is delivered; as the film growth becomes surface-reaction dependent, the lines curve. The horizontal line indicates a region in which there is not enough sulfur to react with all the cadmium being delivered to the substrate.

Experimental evidence indicates that photovoltaic-grade CdS can only be made when the rate of film growth is controlled by the rate at which

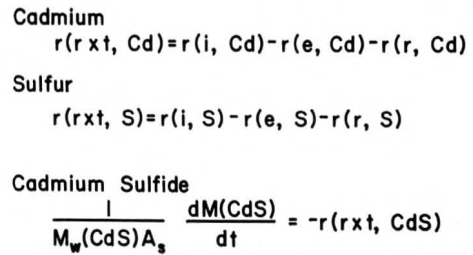

FIGURE 8. Component mass balances.

cadmium and sulfur react on the surface to form CdS. Furthermore, if sulfur is not present when a cadmium molecule arrives at the surface, the cadmium will reflect and not adhere. We are just beginning to try to relate these observations to film properties. This second laboratory scale study of Jackson's is an attempt to learn more about the semiconductor chemical reaction engineering necessary for the field to progress in an orderly fashion. A much more complicated set of chemical equations will be considered in the section on chemical vapor deposition.

Unit Operations Scale Research

For large area applications uniform defect-free film with the required properties must be deposited over areas on the order of meters in dimension. It may be necessary to deposit on a moving substrate to lower costs to the level required to make a large area application like photovoltaics economically feasible. In this section the cooperative research efforts in photovoltaic unit operations between the Department of Chemical Engineering and the Institute of Energy Con-

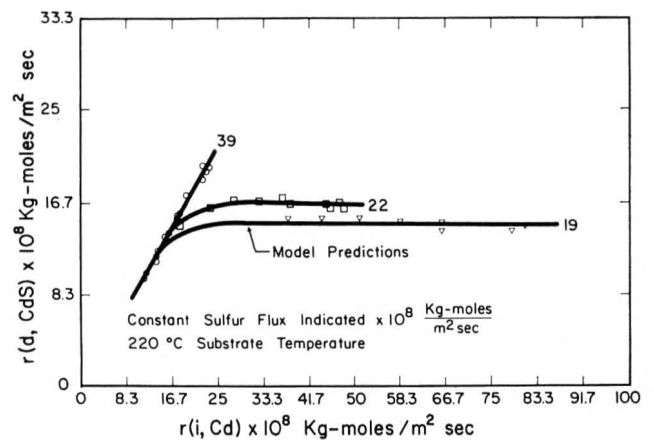

FIGURE 9. Deposition versus incident rate of cadmium in cadmium sulfide.

The theoretical and experimental work of Rocheleau, Rocheleau et al, and Jackson provide the verified models of the laboratory scale batch experiments that can be used to design apparatus and experiments at the unit operations scale.

version at the University of Delaware will be described.

CdS is the wide bandgap window semicon-

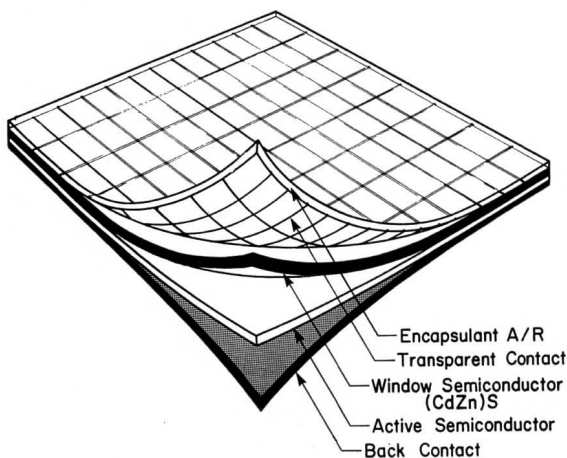

FIGURE 10. Thin-Film polycrystalline solar cell.

ductor for the following polycrystalline hetero-junction cells (Fig. 10)

- CdS/CuInSe₂
- CdS/CdTe
- CdS/Cu₂S

All of the above devices have achieved conversion efficiencies (percentage of sun energy converted to electricity) of just over 10%, although in the case of Cu₂S cells some ZnS had to be alloyed with the CdS. At this conversion efficiency, inexpensive electrical power generation begins to become feasible if modules containing the individual cells can be made cheaply. A first step in meeting this goal is to find a way to continually

TABLE 1
Approximate Throughput and Size Specifications

	Lab. Scale Exps.	Unit Ops. Scale Expts.	Commercial Scale Production
Throughput (m ² /year)	1-100	1,000-20,000	100,000-1,000,000
Deposition Chamber (m ³)	0.1-0.5	1-3	10-30

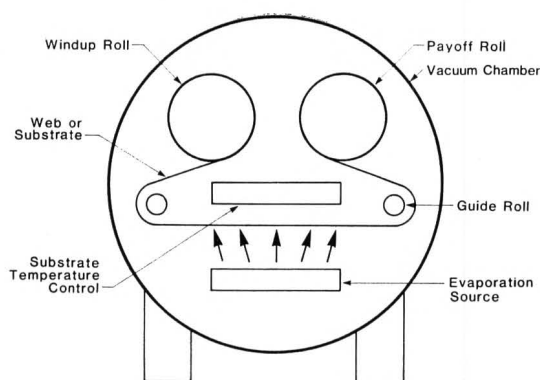

FIGURE 11. Unit operations scale deposition system.

deposit the CdS on a moving substrate.

The theoretical and experimental work of Rocheleau [6], Rocheleau et al [4] and Jackson [5] provide the verified models of the laboratory scale batch experiments that can be used to design apparatus and experiments at the unit operations scale. Throughputs and chamber sizes for typical units are shown in Table 1 for the three scales of operation of interest. The laboratory scale experiments are almost always batch experiments on a static substrate. The unit operations and commercial scale equipment for photovoltaics need to be designed for continuous deposition on a moving substrate.

A sketch of the unit operations scale equipment used at the Institute of Energy Conversion

TABLE 2
Deposition Unit Specifications

Chamber—1.28 m diameter × 1.34 m long
Vacuum—Pump-down to 5 × 10 ⁻⁶ torr in 2 hours
Web
Capacity—500 mm maximum width 250 mm roll diameter (200 m Cu foil)
Web
Speed—1.2 to 12 cm/min
Deposition
Zone—45 cm × 10 cm
Source—A proprietary design (U.S. Patent 4,325,986) providing:
• Constant rate—2 micron/min
• Uniformity over 20 cm wide zone
• 80% CdS utilization
Web
Temperature—200 to 225 °C
Throughput—0.6 to 6 m ² /shift

is shown in Fig. 11. This piece of equipment was designed using model equations similar to those presented as Fig. 5 and 6 and modified for a multi-orifice geometry and the different source-substrate geometry of the unit operations scale equipment. It was also necessary to expand the energy balance analysis to include radiative heat transfer between the source and substrate. The model equations, their behavior and their influence on the design and operation of the unit operations scale reactor are given by Rocheleau [6] and Griffin [7]. The specifications determining the equipment are shown in Table 2 and a photograph of the equipment is shown as Fig. 12.

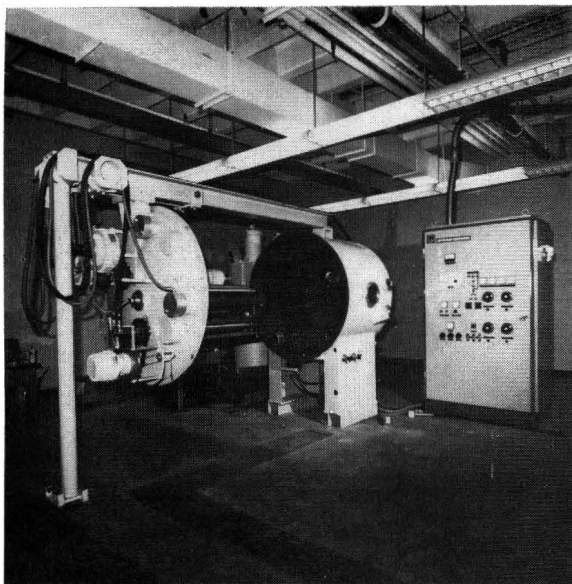

FIGURE 12. Photograph of unit operations scale deposition system.

The unit operations experimentation consisted of controlled deposition of CdS on rolls of zinc plated copper foil. Throughput of the foil ranged from 180 to 600 cm² per hour with film growth rates ranging from 0.5 to 2 μm/min. Substrate temperatures were varied between 200°C and 250°C. At throughputs of 400 cm²/hour, up to 3000 cm² of 25 μm thick CdS was prepared in a single run. Fig. 13 compares a cross-section of continuously deposited CdS with that of photovoltaic-grade batch deposited CdS. X-ray diffraction confirms predominantly c-axis orientation for the continuously deposited CdS. Resistivities of the continuously deposited CdS films ranged from about 1 to 100 ohm-cm. Resistivity of the best laboratory CdS ranges from 1 to 10 ohm-cm.

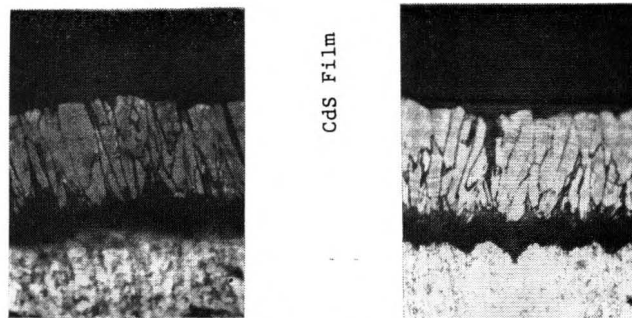

FIGURE 13. Cross-Section of CdS film. Cross-section of continuously-deposited CdS on left, cross-section of batch-deposited CdS on right.

The principal means of evaluating the CdS was to measure the photovoltaic response of cells fabricated using the material from the unit operations experiments. Results are summarized in Table 3 which shows the efficiencies of CdS/Cu₂S cells made using both laboratory scale and unit operations scale CdS. The Cu₂S layer can be made using a wet process by dipping CdS into a CuCl solution or it can be made using a dry process in which CuCl is evaporated onto the CdS and then allowed to react with Cu₂S. A quantitative description is given by Brestovansky et al [8]. Cells made by the dry process in the unit operations scale equipment had both layers, CdS and Cu₂S, continuously deposited on the moving substrate. Cells made by the wet process had to have the Cu₂S layer made in a batch operation. All cells had an evaporated gold front contact.

The efficiency figures show that the unit operations scale continuously deposited CdS is virtually of the same photovoltaic quality as the laboratory scale batch deposited CdS. It took some ten years of research to achieve the efficiencies shown for the batch deposited CdS. The continuously deposited CdS reached the efficiency shown in well under two years of unit operations experimentation. This could only have been achieved by drawing heavily

Continued on page 106.

**TABLE 3
Cell Efficiencies (CdS/Cu₂S)**

	Laboratory Scale (Batch)	Unit Operations Scale (Continuous)
Wet Process (CdS Only)	9%	8%
Dry Process (CdS/Cu ₂ S)	7%	7%

of the enormous unit operations laboratory into offices and small research labs. New electrical and other services will be provided, along with central air conditioning. The average faculty office will shrink from over 400 to a more modest 200 square feet and the offices will be grouped more closely, to stimulate greater interaction among the occupants. The total estimated cost is some fifteen times the original cost of the building. A fund drive for the first stage is being launched. □

AWARD LECTURE

Continued from page 77.

on the batch experience and using verified mathematical models to both design the equipment and direct the experimentation.

CHEMICAL VAPOR DEPOSITION

Laboratory Scale Research

A low pressure chemical vapor deposition (LPCVD) system for amorphous silicon is shown in Fig. 14 and the simplified process flow diagram as Fig. 15. Reactants, Si_2H_6 , and material for doping the film, PH_3 and B_2H_6 , in a stream of argon are controlled by valves at the inlet to the reactor. The tubular quartz reactor is temperature controlled inside an electric furnace. System pressure is controlled manually with a valve at the exit. Effluent gas can be analyzed by gas chromatography and unreacted material is decomposed in a furnace before venting. The detailed operation of this system is described by Bogaert [9].

This effort in amorphous silicon research, spon-

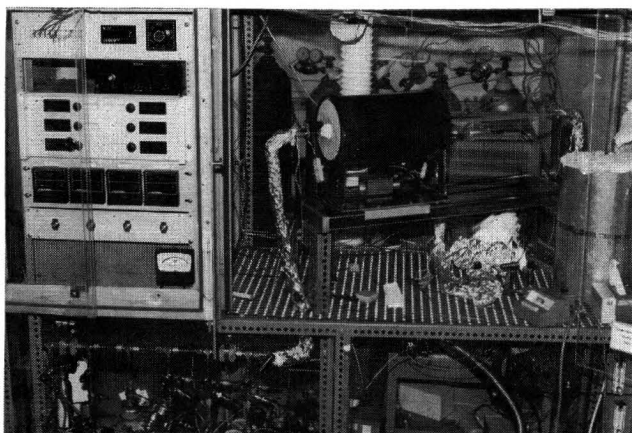

FIGURE 14. Photograph of Low Pressure Chemical Vapor Deposition unit (LPCVD).

sored by the Department of Energy through the Solar Energy Research Institute, is ongoing at the present time and is far from being complete. I am discussing it here to allow the reader to contrast and compare with the physical vapor deposition reacting systems just described.

The chemistry is much more complex for amorphous silicon than for CdS and not well

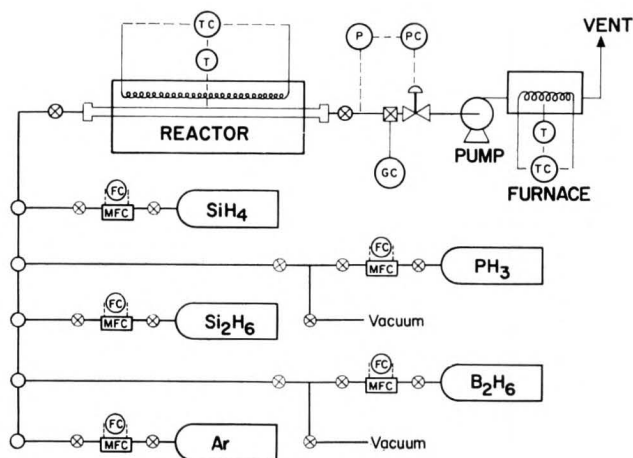
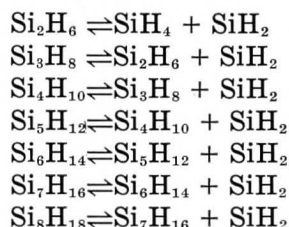

FIGURE 15. Simplified process flow diagram of LPCVD.

understood. The present state-of-the-art is shown below:

Gas Phase



Film Formation

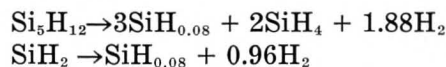

This is a preliminary set of chemical equations. The gas phase equations are based on the results of Ring [10], John and Purnell [11], and Bowery and Purnell [12]. The film formation equations are based upon our own preliminary research.

The component mass balance equations for this tubular reactor system are given below:

Gas Phase

$$\left(\frac{4q}{\pi D^2}\right) \frac{dC_i}{dZ} = \sum r(\text{rxt}, i) + k_g a (C_i - C_{is})$$

Surface

$$0 = k_g a (C_i - C_{is}) - k_s a (\gamma_i C_i)$$

Film

$$\frac{1}{MW_f} \frac{d\rho_f V_f}{dt} = k_s a (\gamma_i C_i)$$

Both the gas phase composition and the film growth rate are functions of axial position. Film growth rate (i.e., amount of amorphous silicon deposited) at any axial position can be determined but it has been possible to measure gas composition only at the reactor exit. The gas and solid phase mass balance equations are coupled through the chemistry of film formation and the transfer from the bulk gas to the surface.

Solution of the model equations produces the gas phase exit composition versus reactor holding time plots shown as Figs. 16 and 17. The solid lines were obtained using our present "best" estimates of the specific reaction constants. This "best" estimate is now obtained by using the experimentally determined growth rate in the solution of the set of mass balance equations. The agreement between data and the predicted values is only fair but we expect to improve the model

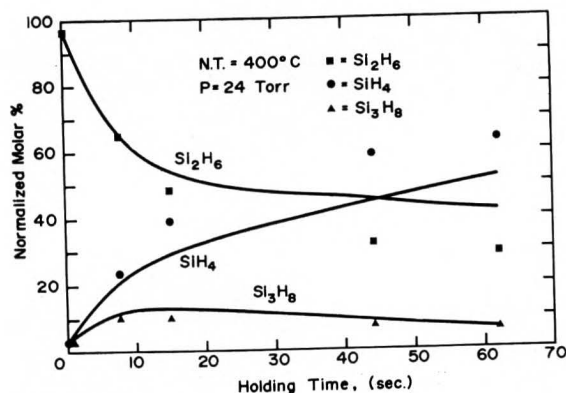

FIGURE 16. Normalized molar percentages versus holding time: Major silanes.

predictions as we learn more about the system.

This research on the chemical reactor and reaction engineering for amorphous silicon in the LPCVD reactor is closely coupled with studies of the material and electronic properties of the film and much effort has been devoted to finding the best conditions for good photovoltaic amorphous silicon. To date, we have been able to make a 4% solar cell using material from the LPCVD reactor. These efforts are described in the work of Hegedus et al [13].

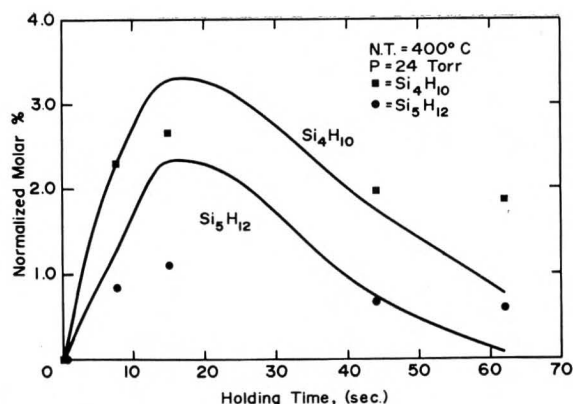

FIGURE 17. Normalized molar percentages versus holding time: Minor silanes.

CONCLUDING REMARKS

Incorporating chemical reactor and reaction engineering analysis into a semiconductor research effort requires the researchers to achieve a quantitative understanding of both the molecular phenomena and the transport phenomena associated with the creation of the semiconductor materials. A test of this understanding is the ability to write useful mathematical descriptions of the laboratory scale reacting system. Mathematical descriptions are an essential part of the analysis because they provide the language which allows the professionals doing the research to effectively and unambiguously communicate with each other. Communication is easier if the models are simple and, of course, the model predictions must be verifiable by experiment. In fact, the model behavior should be used to plan the experimental program because an enlightened use of a chemical reaction and reactor engineering analysis will identify critical molecular and transport phenomena problems and direct experimental attention to them with the proper priorities.

We originally became interested in the semiconductor research because of a need to design larger scale reacting systems. However, the last five years of research has taught us that the chemical engineering analysis is very useful in the laboratory scale research effort, and indeed essential, if such research is to be done efficiently and with minimum expense (a key issue with today's research costs).

It is not possible, in our view, to effectively design and operate larger scale systems without reaction and reactor engineering analysis. In photo-

voltaic applications it is also necessary to carry out analysis and experimentation at the unit operations scale. Those who have attempted to scale up without following these procedures have wasted time and money building equipment which is inadequate for the commercial scale processing of solar cells.

A useful start has been made in applying chemical engineering analysis to the deposition of thin-film semiconductors but much effort now must be devoted to the task of relating electronic and optical properties to the design and operation of a reacting system. When we have learned to do this properly, we can begin to "tailor-make" material with any desired property.

ACKNOWLEDGMENTS

Semiconductor chemical reaction and reactor research requires a team effort involving a number of professionals. I am particularly indebted to B. N. Baron, R. E. Rocheleau, S. C. Jackson and R. J. Bogaert, my chemical professional colleagues at the Institute of Energy Conversion. Their analysis, their effective experimentation and their discussions with me have been essential to the development of this field. None of the research could have been carried out without the excellent semiconductor material development and analysis and device design and analysis that my other colleagues at the Institute of Energy Conversion do so well. I am also in their debt for their willingness to educate a chemical engineer in the art and science of applied solid state physics.

Science and engineering research today requires some considerable management talent. The Department of Energy's photovoltaic office and the Solar Energy Research Institute have worked very hard to develop a rational plan for photovoltaic research that both produces results and handles the political pressures that arise in a budget conscious government. The management group within the Institute of Energy Conversion is unique in its capability to protect the director from administrative detail and to allow me to put most of my effort into technical work. I would like to thank S. Barwick and M. Stallings for this gift. □

REFERENCES

1. Thornton, J. A., Annual Rev. of Material Science, 7, p. 239 (1977).
2. Kern, W. and V. S. Ban, *Thin Film Processes*, (J. Vossen and W. Kern, editors) Academic Press, New York (1978).

3. Dutton, R. W., "Modeling of the Silicon Integrated Circuit Design and Manufacturing Process," *IEEE Trans. Electron Dev.*, 30, 9, p. 968 (1983).
4. Rocheleau, R. E., B. N. Baron and T. W. F. Russell, "Analysis of Evaporation of Cadmium Sulfide for the Manufacture of Solar Cells," *AIChE Journal*, 28, 4, p. 656 (1982).
5. Jackson, S. C., PhD Thesis, "Engineering Analysis of the Deposition of Cadmium-Zinc Sulfide Semiconductor Film," University of Delaware (1984).
6. Rocheleau, R. E., PhD Thesis, "Design Procedures for a Commercial Scale Thermal Evaporation System for Depositing CdS For Solar Cell Manufacture," University of Delaware (1981).
7. Griffin, A. W., MChE Thesis, "Modeling and Control of a Unit Operations Scale System to Deposit Cadmium Sulfide for Solar Cell Manufacture," University of Delaware (1982).
8. Brestovansky, D. F., B. N. Baron, R. E. Rocheleau and T. W. F. Russell, "Analysis of the Rate of Vaporization of CuCl for Solar Cell Fabrication," *J. Vac. Sci. Technol. A*, 1, 1, p. 28 (1983).
9. Bogaert, R. J., PhD Thesis, "Chemical Vapor Deposition of Amorphous Silicon Films," University of Delaware (1985).
10. Ring, M. A., "Homoatomic Rings, Chains and Macromolecules of Main Group Elements," Elsevier, N.Y., 1977, Ch. 10.
11. John, P. and J. H. Purnell, *Faraday Trans. I*, 69, p. 1455 (1973).
12. Bowery, M. and J. H. Purnell, *Proc. Roy. Soc. Lond.*, A321, p. 341 (1971).
13. Hegedus, S. S., R. E. Rocheleau and B. N. Baron, "CVD Amorphous Silicon Solar Cells," Proceedings of the 17th IEEE Photovoltaic Specialists Conference—Orlando, p. 239 (1984).

NOMENCLATURE

a	area
C_i	concentration of species i
D	diameter of reactor
K	effective reaction rate constant
k	reaction rate constant
k_g	mass transfer coefficient
MW	molecular weight
q	volumetric flow rate
r(e)	rate of evaporation
r(i)	impingement rate, species i
r(r)	rate of reflection
r(rxt,i)	net rate of reaction, species i
V	volume
Z	axial position in tubular reactor

Greek

δ	condensation coefficient
γ	stoichiometric coefficient
ρ	density

Subscripts

f	film property
g	gas phase
i	molecular species
s	denotes on the surface